



HomePod

Apple Recycler Guide

May 2023

Contents

3	About This Guide
4	Identification
5	Directive 2012/19/EU Annex VII Components
6	Safety Considerations
7	Recommended Tools
8	Disassembly Instructions
27	Material Categorization of Output Fractions

About This Guide

Apple Recycler Guides provide guidance for electronics recyclers on how to disassemble products to maximize recovery of resources. The guides provide step-by-step disassembly instructions and information on the material composition to help recyclers direct fractions to the appropriate material recycler.

To conserve important resources, we work to reduce the materials we use and aim to one day source only recycled or renewable materials in our products. A key path to reaching that goal is resource recovery from end-of-life electronics.

Disassembly procedures are intended to be performed only by trained electronics recycling professionals. The recycler is responsible for independently evaluating and ensuring compliance with all applicable environmental, health, and safety laws related to the work. These include but are not limited to laws relating to the management, handling, shipping, and disposal of the outputs of this work as waste and laws in place to ensure the health and safety of all employees who support this work.

For questions or feedback about this guide, email contactesci@apple.com.

Identification

You can find the model number on the bottom of the HomePod.



Model number:
A1639

Directive 2012/19/EU Annex VII Components

Directive 2012/19/EU Annex VII requirements apply to the following substances and components.

Substance/Component	Apple Part Name	Removal Instructions
Printed circuit board if the surface is greater than 10 square centimeters	Main logic board, power supply logic board, amplifier logic board	Follow steps 1–15
External electric cables	Power cord	Follow step 1
No further substances or components as listed in Annex VII		

Safety Considerations

The recycler is responsible for independently evaluating all activities undertaken by its employees to perform or support the work and ensuring compliance with all applicable health and safety laws related to the work. These include but are not limited to laws relating to the health and safety of all employees who perform or support this work. The recycler is also responsible for evaluating the workspace and ensuring that the area in which the work is to be undertaken is designed using ergonomic best practices and meets all ergonomic requirements to ensure the protection of its employees.

Personal Protective Equipment

Personal protective equipment should be worn during the entire recycling process.



Wear hand protection



Wear protective clothing



Wear eye protection



Wear foot protection

Recommended Tools

Miniature pry bar

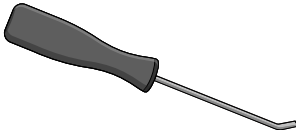

Nail-pulling screwdriver

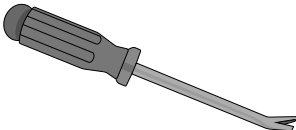

Screwdriver-handle pry bar

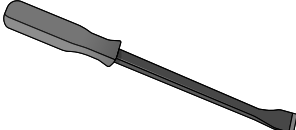

Slip-joint pliers

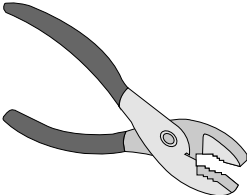

Torx T6 screwdriver

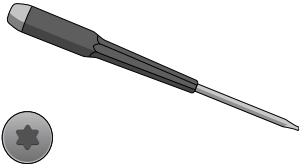

Disassembly Instructions

1. Disconnect the power cord.

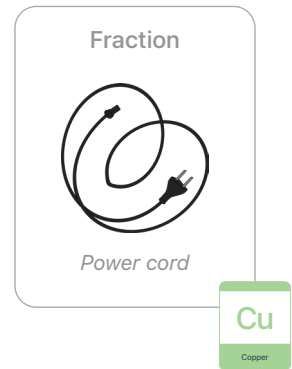
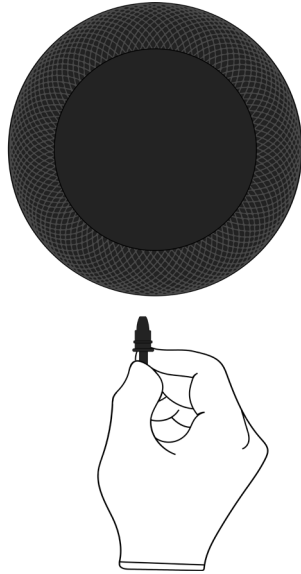

Warning: Before continuing disassembly, wait 10 minutes after unplugging the device for stored energy to discharge.

2. Pry the base off the bottom of the HomePod.

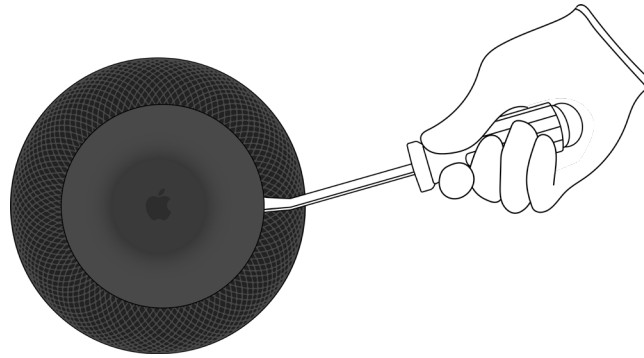

Tools Used

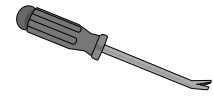

Fraction



Base

PL

Plastics

3. Loosen the module cover by prying underneath it.

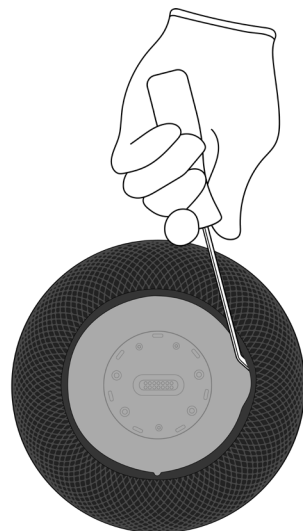

Tools Used



4. Pry the cap off the top of the HomePod.

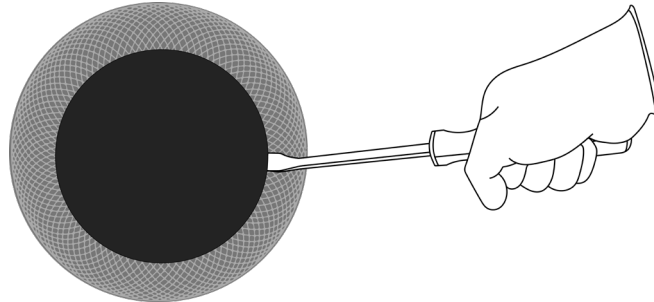

Tools Used



Fraction

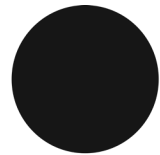

Cap

PL

Plastics

5. Remove the touch sensor assembly.

» Unscrew the four Torx T6 fasteners.

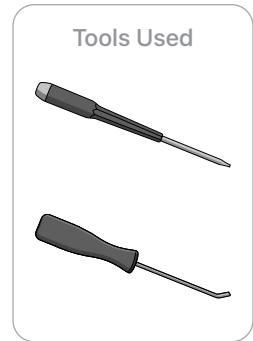
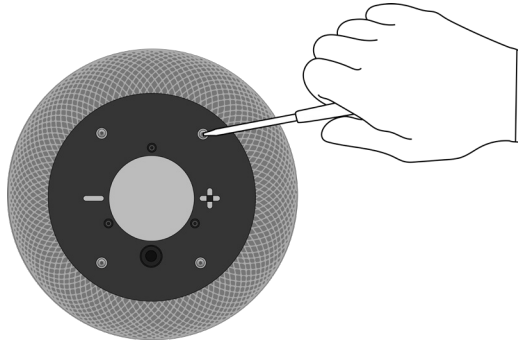

» Pry off the touch sensor assembly.

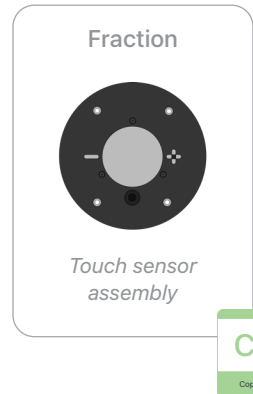
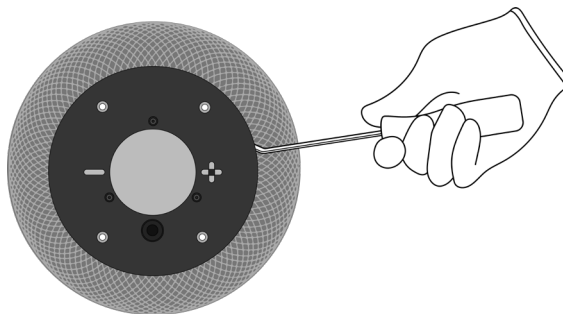

6. Remove the touch sensor support frame by unscrewing the six Torx T6 fasteners.

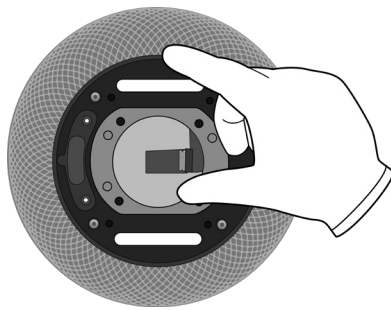
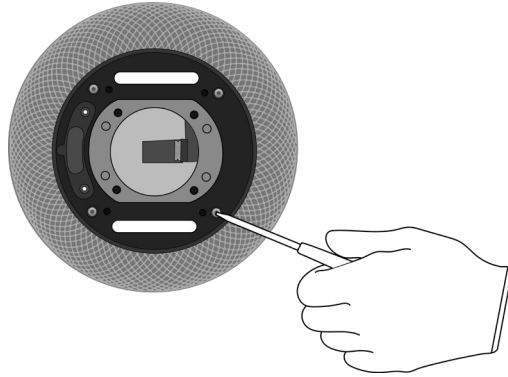

Tools Used

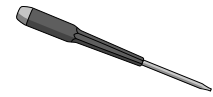

Fraction



Fasteners (x6)

Fe

Ferrous

Fraction

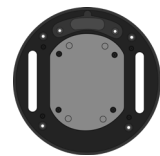

Touch sensor support frame

PL

Plastics

7. Slide off the module cover.

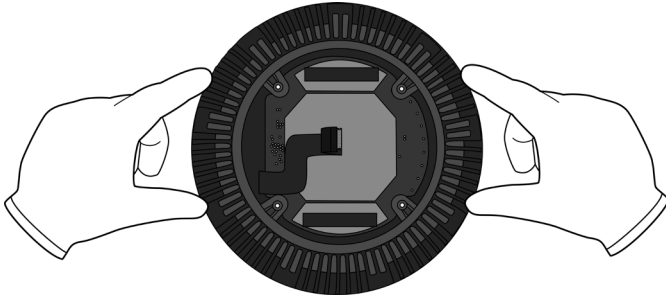

8. Remove the main logic board.

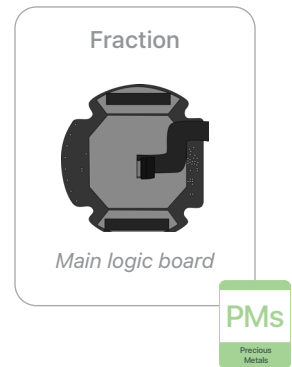
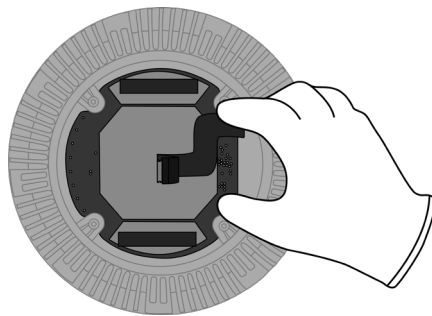

9. Separate the enclosure cover from the enclosure.

» Pry the nine fastener covers off the enclosure cover.

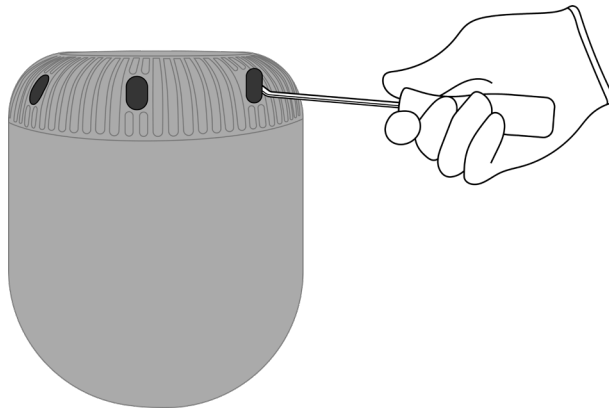
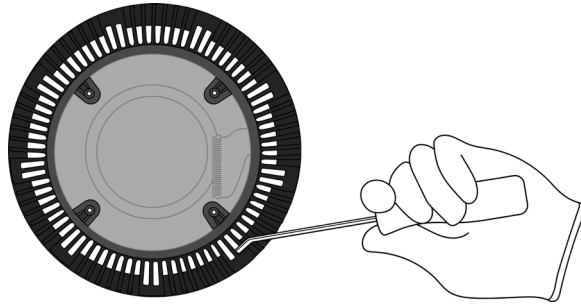

» Unscrew the nine Torx T6 fasteners.

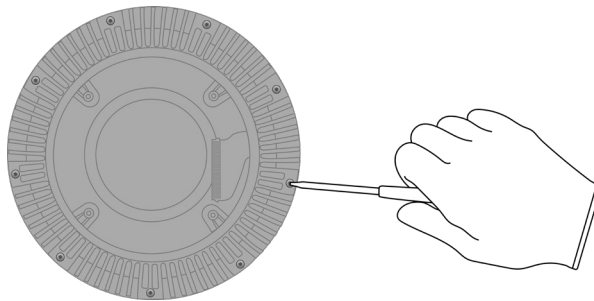

Tools Used

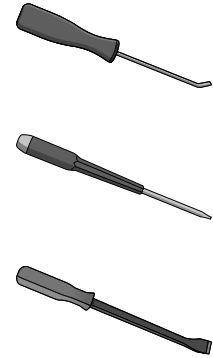

Fraction



Fastener covers (x9)

PL

Plastics

Fraction



Fasteners (x9)

Fe

Ferrous

» Pry off the enclosure cover. Set the enclosure aside.

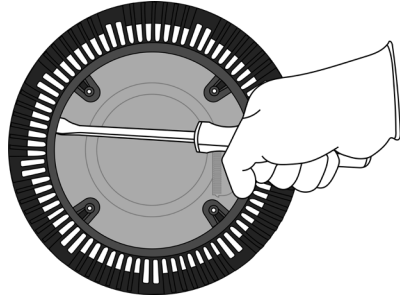

10. Remove the ribbon cable.

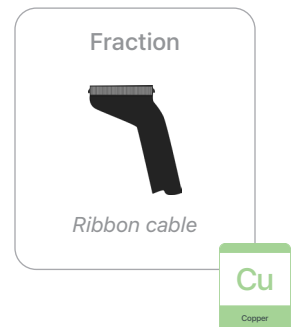
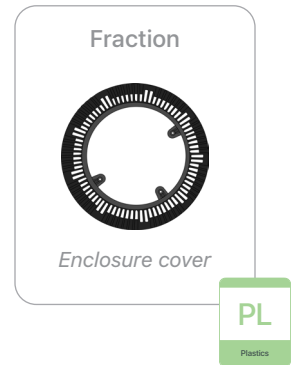
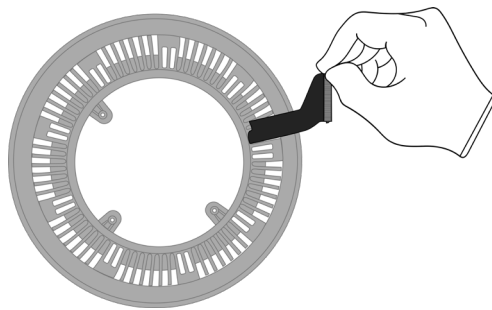

- 11.** Remove the woofer by unscrewing the six Torx T6 fasteners.

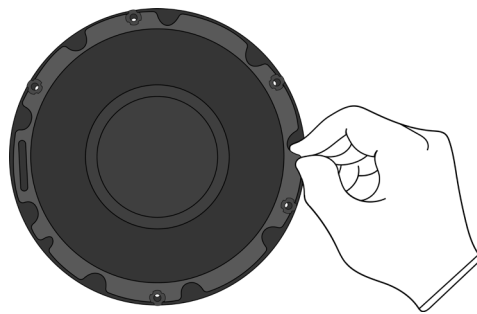
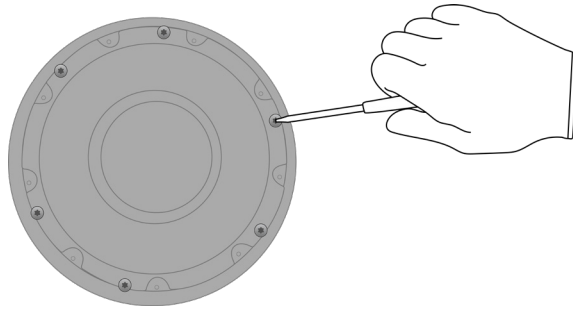

Tools Used

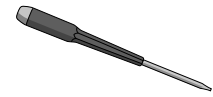

Fraction



Fasteners (x6)

Fe

Ferrous

Fraction

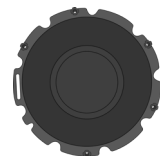

Woofer

Cu

Copper

- 12.** Remove the upper ring by unscrewing the six Torx T6 fasteners.

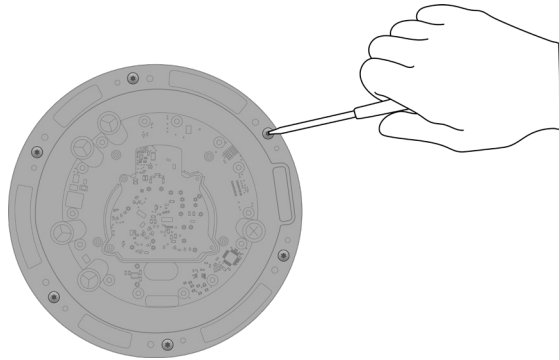

Tools Used

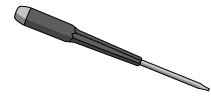

Fraction



Fasteners (x6)

Fe

Ferrous

Fraction



Upper ring

PL

Plastics

13. Remove the middle ring by turning it by hand.

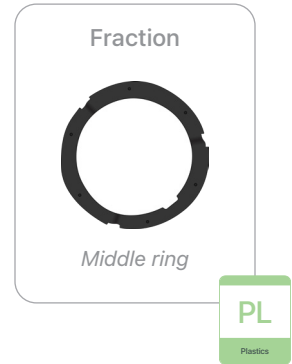
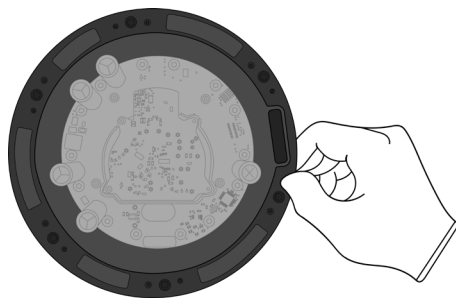
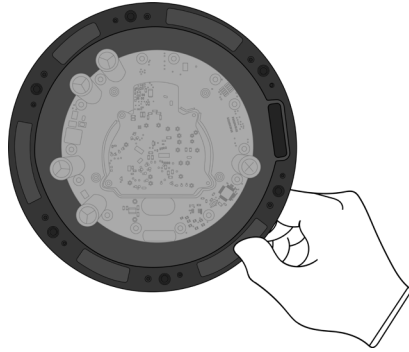

14. Remove the power supply logic board by unscrewing the four Torx T6 fasteners.

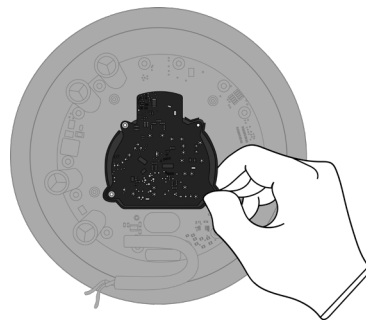
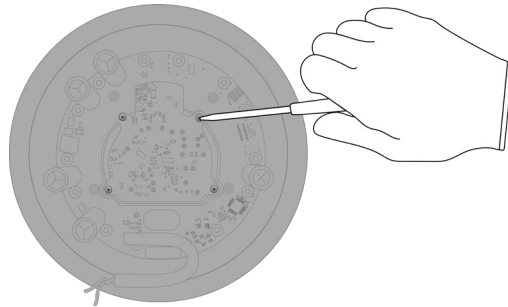

Tools Used

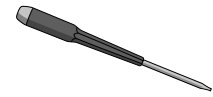

Fraction



Fasteners (x4)

Fe

Ferrous

Fraction

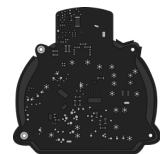

Power supply
logic board

PMs

Precious
Metals

- 15.** Remove the amplifier logic board by unscrewing the 14 Torx T6 fasteners.

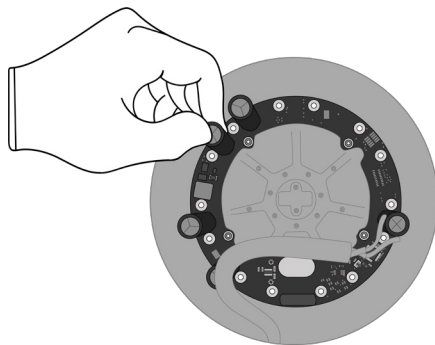
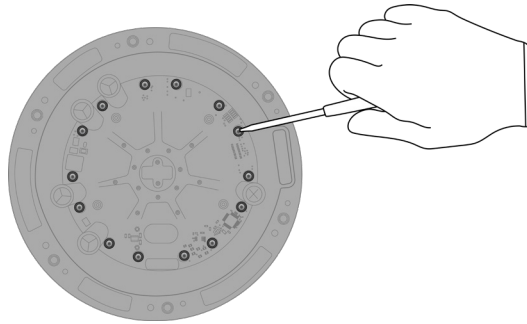

Tools Used

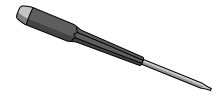

Fraction



Fasteners (x14)

Fe

Ferrous

Fraction



Amplifier logic board

PMs

Precious Metals

16. Pry off the microphone array.

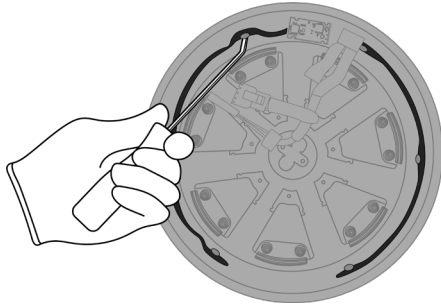

Tools Used



Fraction



Microphone array

Cu
Copper

17. Pry off the microphone logic board.

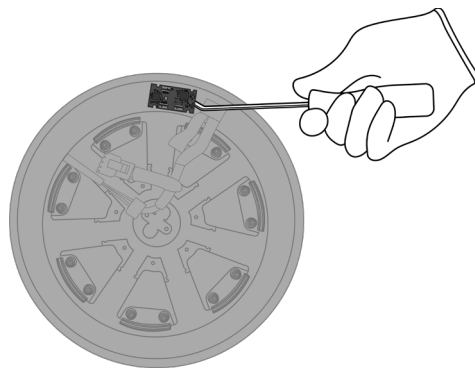

Tools Used



Fraction



Microphone logic board

PMs
Precious Metals

18. Pry off the tweeter retaining ring.

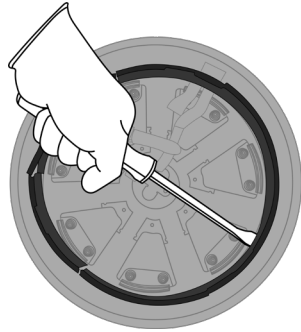

Tools Used

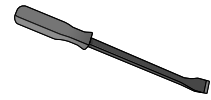

Fraction



Tweeter retaining ring

PL

Plastics

19. Remove the tweeters.

» Unscrew the 14 Torx T6 fasteners.

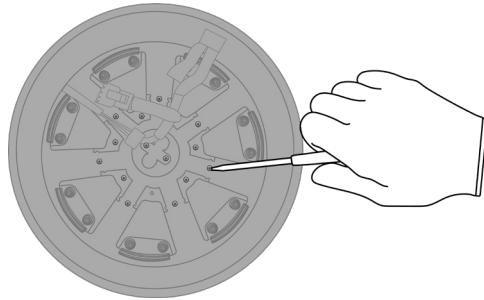

Tools Used

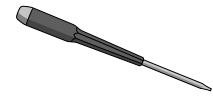

Fraction



Fasteners (x14)

Fe

Ferrous

» Remove the seven tweeters by hand.

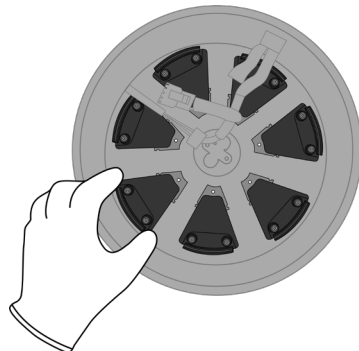

Fraction



Tweeters (x7)

REE

Rare Earth
Elements

- 20.** Separate the ribbon cable by unscrewing the two Torx T6 fasteners. Set the enclosure aside.

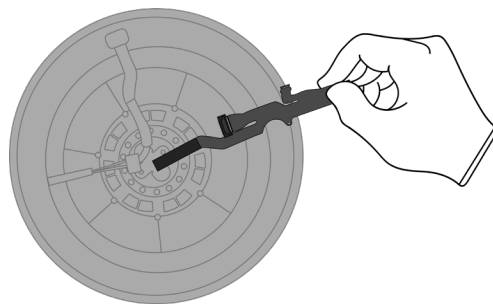
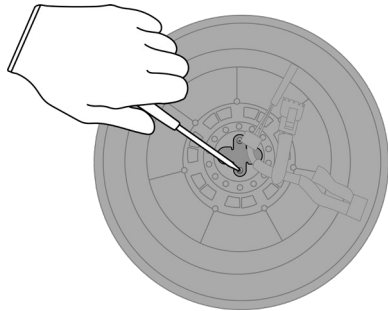

Tools Used

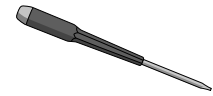

Fraction



Fasteners (x2)

Fe

Ferrous

21. Remove the bracket from the ribbon cable.

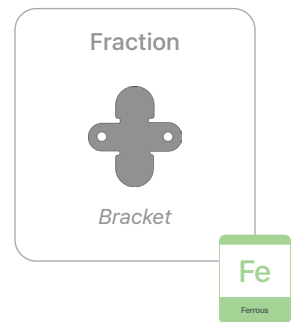
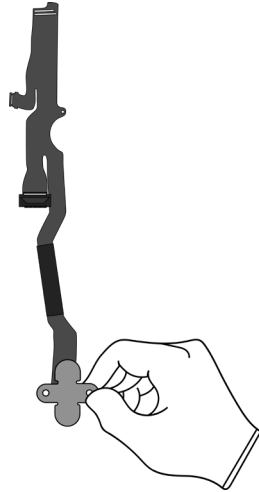

22. Remove the interior power cord.

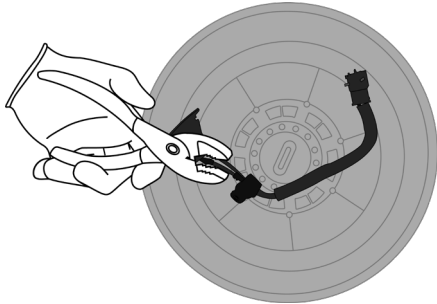

Tools Used

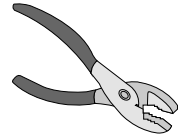

Fraction



Interior power cord

Cu

Copper

Fraction

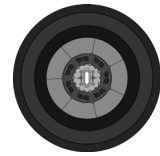









Enclosure

PL

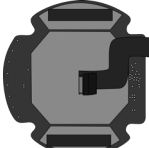
Plastics

Material Categorization of Output Fractions

All outputs from this process must be managed, handled, and disposed of in accordance with applicable waste laws and regulations, including but not limited to the Waste Framework Directive and its national enactments in Europe.

Fraction	Downstream Processing
<p data-bbox="451 554 553 579">Ferrous</p> <div data-bbox="462 625 542 705">  </div> <p data-bbox="423 722 576 743"><i>Fasteners (x65)</i></p> <div data-bbox="454 793 550 894">  </div> <p data-bbox="462 911 542 932"><i>Bracket</i></p>	<p data-bbox="967 554 1276 579">Primary Target Material</p> <div data-bbox="1083 625 1156 714">  </div>
<p data-bbox="415 1033 586 1058">Logic Boards</p> <div data-bbox="427 1104 574 1251">  </div> <p data-bbox="420 1268 581 1289"><i>Main logic board</i></p> <div data-bbox="427 1339 574 1486">  </div> <p data-bbox="380 1503 621 1524"><i>Power supply logic board</i></p>	<p data-bbox="967 1033 1276 1058">Primary Target Material</p> <div data-bbox="1083 1104 1156 1192">  </div> <p data-bbox="927 1260 1315 1285">Potential Additional Materials</p> <div data-bbox="979 1331 1052 1419">  </div> <div data-bbox="1083 1331 1156 1419">  </div> <div data-bbox="1187 1331 1260 1419">  </div>

Logic Boards (cont.)



Amplifier logic board

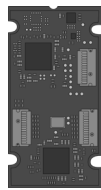

Microphone logic board

Mixed Electronics

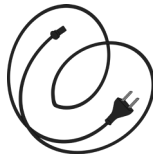

Power cord

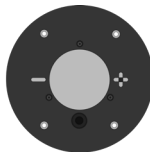

Touch sensor assembly

Primary Target Material



Potential Additional Materials



Mixed Electronics (cont.)



Ribbon cables

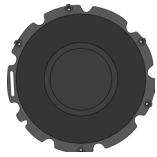

Woofer



Microphone array



Interior power cord

Fraction

Downstream Processing

Mixed Plastics



Base

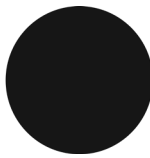

Cap

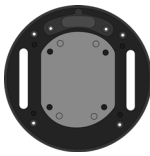

Touch sensor support frame

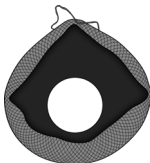

Module cover



Fastener covers (x9)



Enclosure cover

Primary Target Material



Potential Additional Materials



Fraction

Downstream Processing

Mixed Plastics (cont.)



Upper ring



Middle ring



Tweeter retaining ring

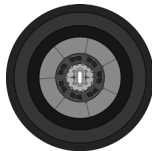

Enclosure

Rare Earth Magnets



Tweeters (x7)

Primary Target Material



Potential Additional Materials

