



MacBook Air (13-inch, 2017)

Apple Recycler Guide

July 2023

Contents

3	About This Guide
4	Identification
5	Directive 2012/19/EU Annex VII Components
6	Safety Considerations
9	Recommended Tools
10	Disassembly Instructions
29	Material Categorization of Output Fractions

About This Guide

Apple Recycler Guides provide guidance for electronics recyclers on how to disassemble products to maximize recovery of resources. The guides provide step-by-step disassembly instructions and information on the material composition to help recyclers direct fractions to the appropriate material recycler.

To conserve important resources, we work to reduce the materials we use and aim to one day source only recycled or renewable materials in our products. A key path to reaching that goal is resource recovery from end-of-life electronics.

Disassembly procedures are intended to be performed only by trained electronics recycling professionals. The recycler is responsible for independently evaluating and ensuring compliance with all applicable environmental, health, and safety laws related to the work. These include but are not limited to laws relating to the management, handling, shipping, and disposal of the outputs of this work as waste and laws in place to ensure the health and safety of all employees who support this work.

For questions or feedback about this guide, email contactesci@apple.com.

Identification

You can find the model number on the underside of the MacBook Air.

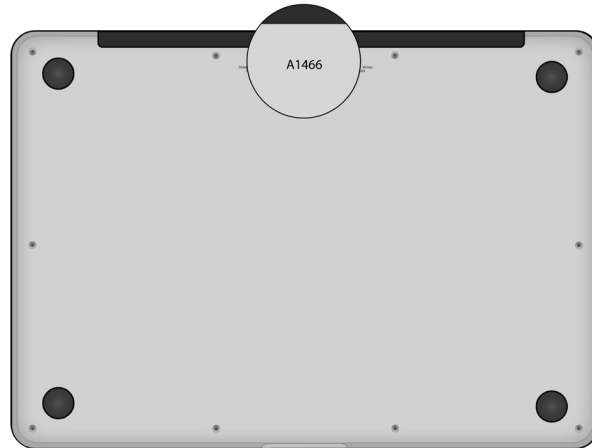

Model number:
A1466

Directive 2012/19/EU Annex VII Components

Directive 2012/19/EU Annex VII requirements apply to the following substances and components.

Substance/Component	Apple Part Name	Removal Instructions
Printed circuit board if the surface is greater than 10 square centimeters	Main logic board, keyboard, data board assembly, light-emitting diode (LED) logic board	Follow steps 1–26
External electric cables	Charge cable	Follow step 1
Battery	Lithium-ion polymer batteries	Follow steps 1–3
Cover glass and liquid crystal display (LCD) cell if the surface is greater than 100 square centimeters	LCD cell	Follow steps 1–25
No further substances or components as listed in Annex VII		

Safety Considerations

The recycler is responsible for independently evaluating all activities undertaken by its employees to perform or support the work and ensuring compliance with all applicable health and safety laws related to the work. These include but are not limited to laws relating to the health and safety of all employees who perform or support this work. The recycler is also responsible for evaluating the workspace and ensuring that the area in which the work is to be undertaken is designed using ergonomic best practices and meets all ergonomic requirements to ensure the protection of its employees.

Personal Protective Equipment

Personal protective equipment should be worn during the entire recycling process.



Wear hand protection



Wear a mask



Wear eye protection



Wear foot protection



Wear protective clothing

Battery Safety

This product uses a lithium-ion polymer battery. Before beginning any disassembly work, ensure that a safe working procedure for handling lithium-ion batteries has been established, which could include discharging the batteries so that they can be more safely managed. The following considerations may also be included:

- Remove anything from your person that could conduct energy, such as jewelry and watches, to avoid electric shock to yourself or the logic board.
- To avoid the potential for thermal runaway and the release of potentially noxious fumes, don't puncture, strike, or crush lithium-ion polymer batteries or devices powered by them.
- Don't throw, drop, or bend the battery.
- Don't expose the battery to excessive heat or sunlight.
- Don't use tools that are sharp or conduct electricity.
- Keep your workspace clear of foreign objects and sharp materials.
- Dispose of batteries according to local environmental laws and guidelines.

Workspace safety guidelines

- Use heat-resistant gloves and safety glasses.
- Keep a sand dispenser within arm's reach (2 feet or 0.6 m) on one side of the workstation, not above the workstation. The dispenser should be a wide-mouthed, quick-pour metal container with a flip-top lid or tray that contains 8–10 cups (1.9–2.4 L) of clean, dry, untreated sand.
- Keep the battery at least 2 feet (0.6 m) from paper and other combustible materials.
- Work in an area with adequate ventilation.

Handling a thermal runaway

If you notice any of the following signs, a thermal runaway is likely underway, and you should act immediately:

- The lithium-ion polymer battery or a device containing one begins to smoke or emit sparks or soot.
- The battery pouch suddenly and quickly puffs out.
- You hear hissing or popping sounds.

Don't use water or an ABC/CO₂ fire extinguisher on a thermal runaway battery or a device containing one. Water and ABC/CO₂ fire extinguishers will not stop the reaction.

Do smother the battery or device immediately with plenty of clean, dry sand, dumped all at once. Timing is critical; the faster you pour all the sand, the faster the thermal runaway will stop.

Do leave the room for 30 minutes if the thermal runaway causes any irritation.

Do wait 30 minutes before touching the battery. Wear heat-resistant gloves and safety glasses to remove the battery from the sand, or use a touchless thermometer to measure the battery temperature. Only touch the battery when the event has finished.

Do dispose of the damaged battery or device (including any debris removed from the sand) according to local environmental laws and guidelines.

LED Safety

Broken light-emitting diodes (LEDs) must be handled properly to ensure the safety of your employees and mitigate any hazards. Package broken LEDs in an appropriate container to properly manage the hazards associated with the materials and store only with compatible materials. All waste must be properly classified, packaged, and labeled in accordance with all relevant laws and regulations.

Hazard Warnings



Rechargeable battery hazard



Sharp edges—cut hazard



Broken glass hazard



Chemical exposure hazard



Chemical inhalation hazard

Recommended Tools

Nail-pulling screwdriver

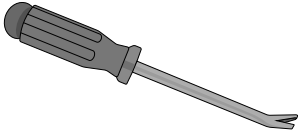

Pentalobe P4 screwdriver

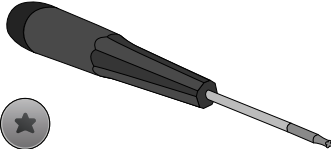

Phillips screwdriver

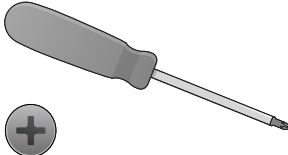

Plastic pry bar

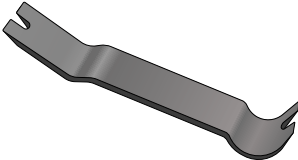

Screwdriver-handle pry bar

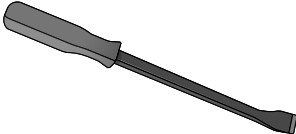

Wire cutters

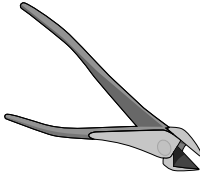

Disassembly Instructions

1. Remove the power adapter and the charge cable.

» *Ensure that the MacBook Air is turned off.*



» *Unplug the power adapter. Disconnect the charge cable.*

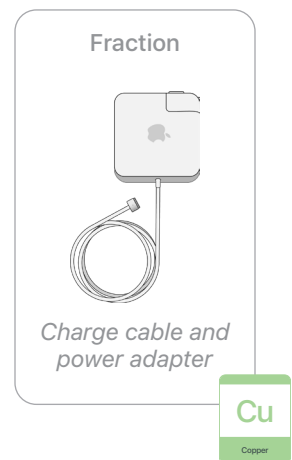

2. Remove the bottom case by unscrewing the 10 pentalobe P4 fasteners.

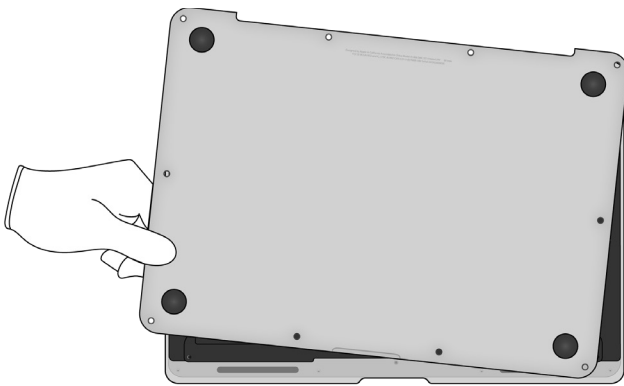
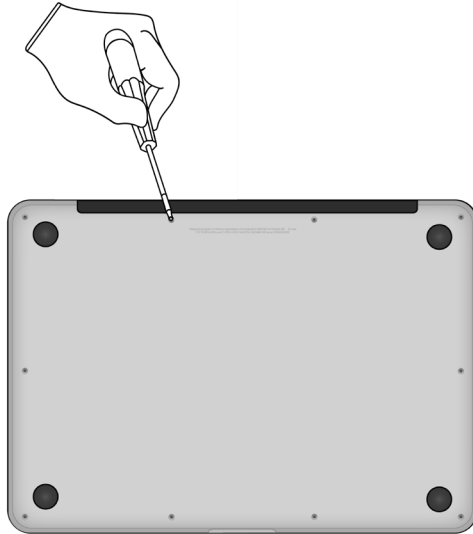

Tools Used

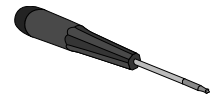

Fraction



Fasteners (x10)

Fe

Ferrous

Fraction

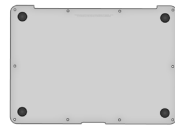

Bottom case

Al

Aluminum

3. From the top case, carefully remove the four lithium-ion polymer batteries.

 Rechargeable battery hazard

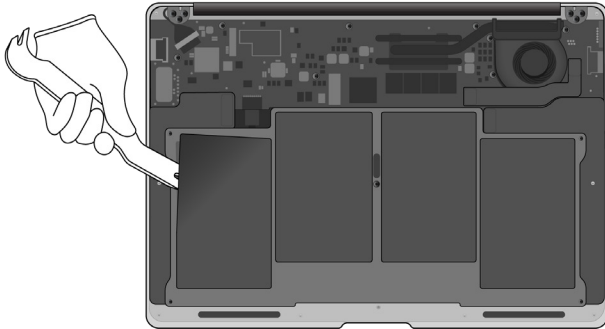

Tools Used



Fraction



Lithium-ion polymer batteries

BT
Battery

4. Pry off both speakers.

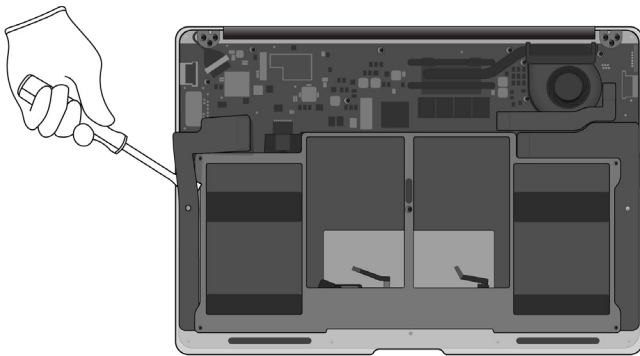

Tools Used



Fraction

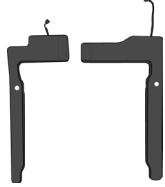

Speakers

REE
Rare Earth Elements

5. Pry off the battery heat shield. Set the top case aside.

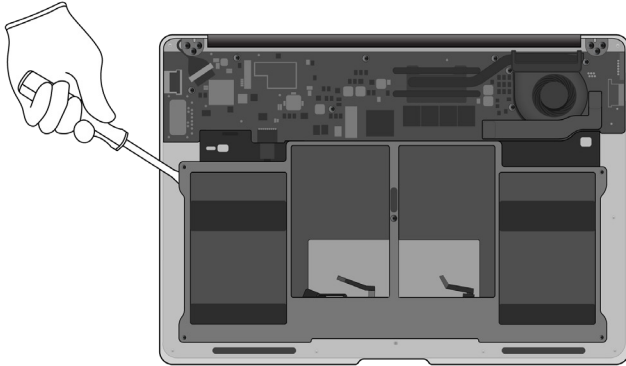

Tools Used

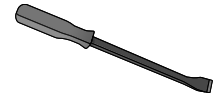

6. Separate the battery heat shield from the power supply cables and logic board.

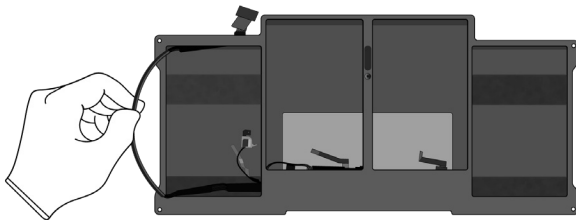

Fraction



Battery
heat shield

Fe

Ferrous

7. Pull the power supply cables off the power supply logic board.

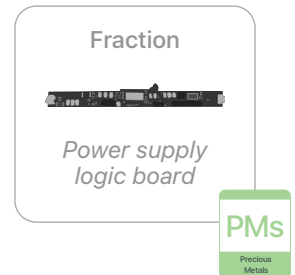
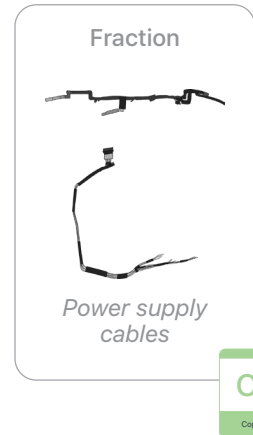
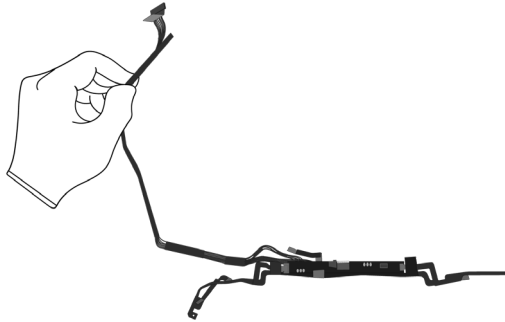

8. Remove the trackpad from the top case.

- » *Push the trackpad down.*
- » *Pull it out from under the top case. Set the top case aside.*

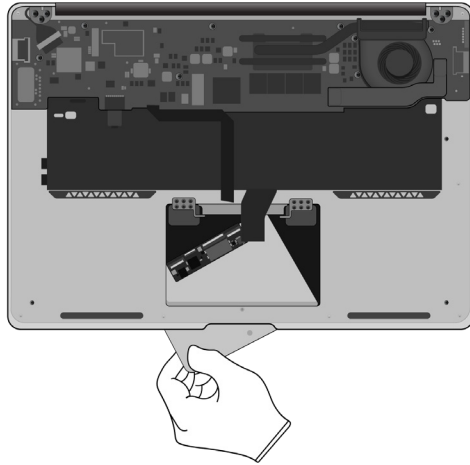

9. Pry off the trackpad logic board.

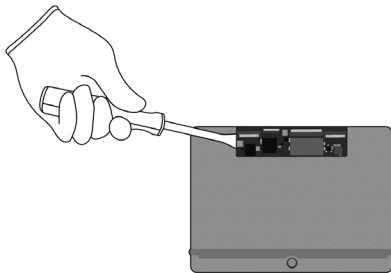

Tools Used

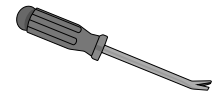

Fraction



Trackpad logic board



10. Pry off the sensor protective film and trackpad plate.

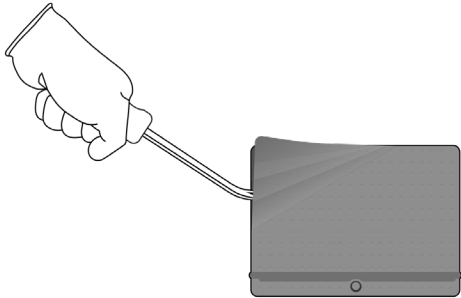

Tools Used

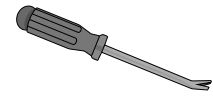

Fraction

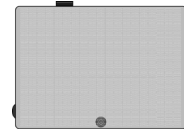

Sensor protective film

Cu

Copper

Fraction



Trackpad plate

Al

Aluminum

Fraction



Trackpad

GL

Glass

11. From the top case, remove the thermal duct.

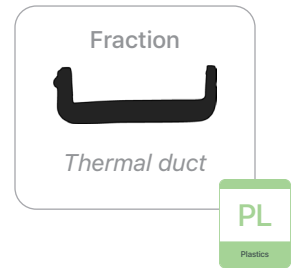
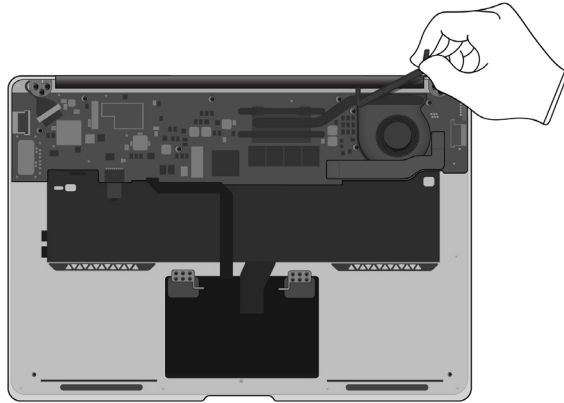

12. Remove the ribbon cable from the main logic board.

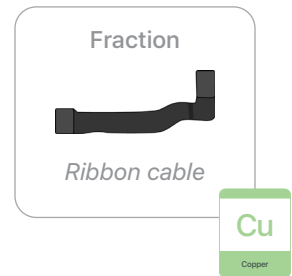
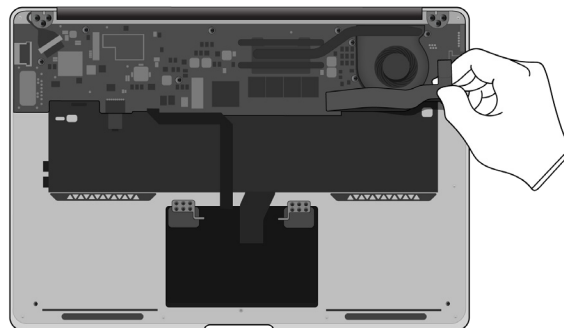

13. Pry off the fan.

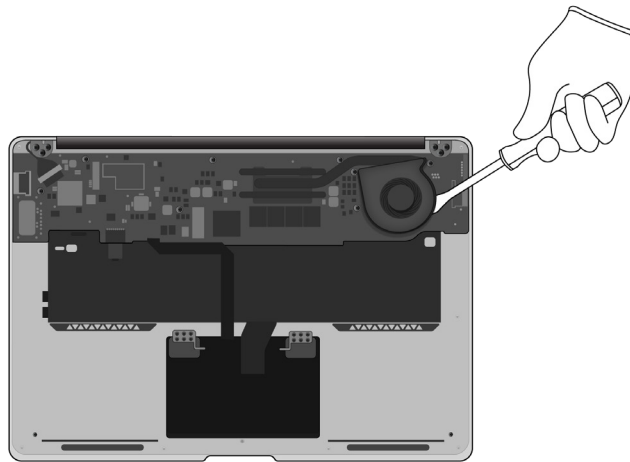

Tools Used



Fraction

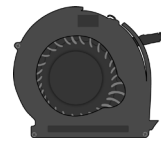

Fan

Cu

Copper

14. Pry off the main logic board.

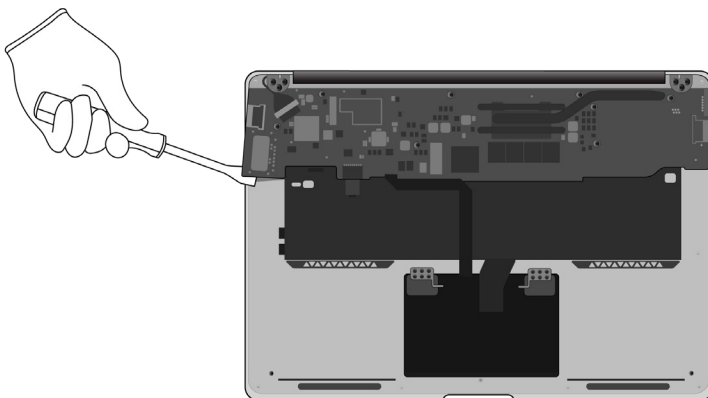

Tools Used

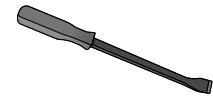

Fraction



Main logic board

PMs

Precious Metals

- 15.** Remove the trackpad ribbon cable and keyboard cable.

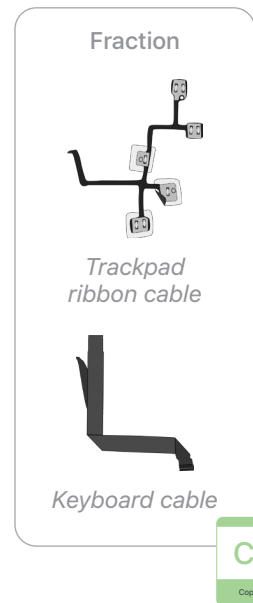
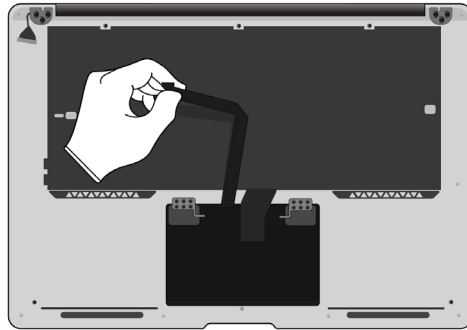

- 16.** Remove the plastic keyboard sheet from the keyboard.

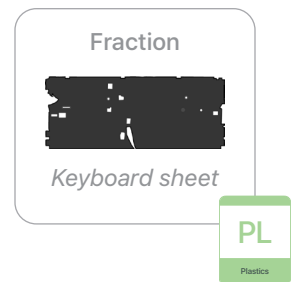
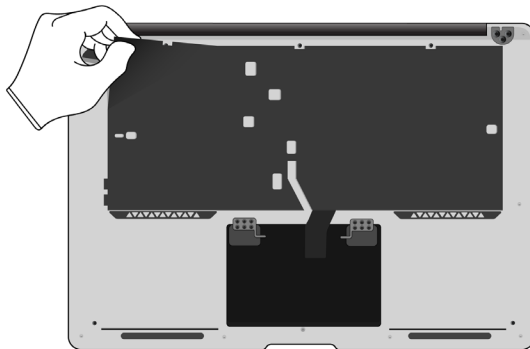

17. Bend the display and top case back and forth until they break apart. Set the display aside.



Sharp edges—cut hazard

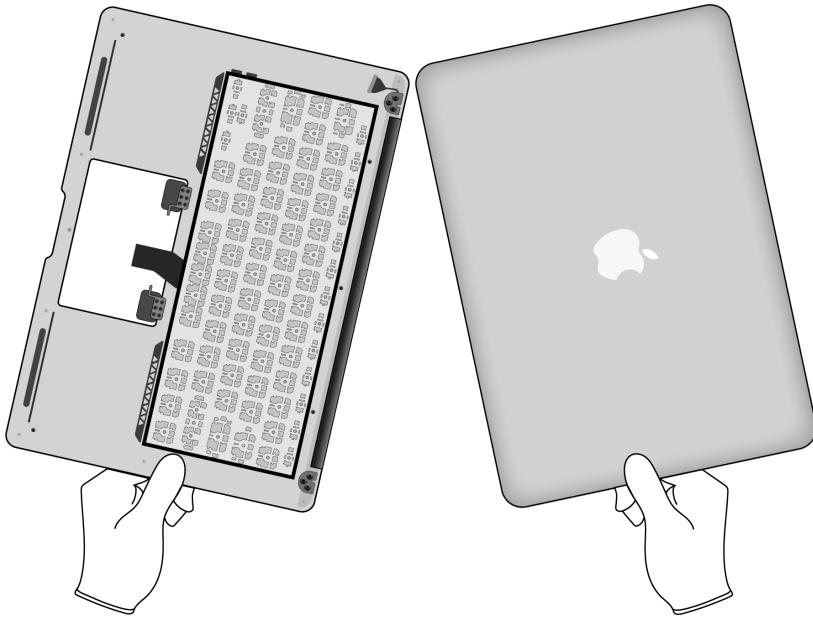

18. Separate the keyboard and trackpad enclosure by breaking the top case in half.

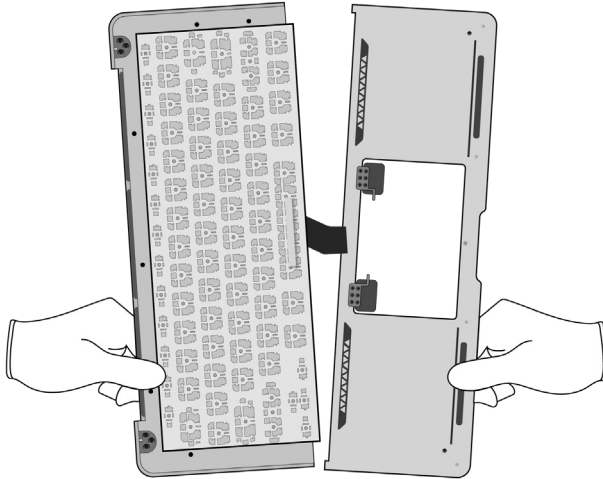
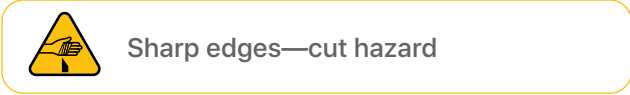

Fraction



Keyboard

PMs
Precious Metals

Fraction



Trackpad enclosure

Al
Aluminum

19. Pry off the display frame.

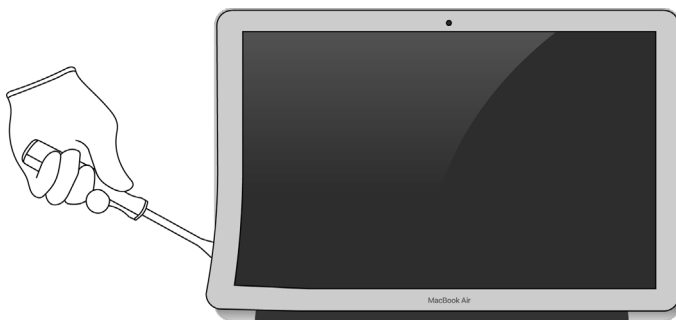

Tools Used



Fraction

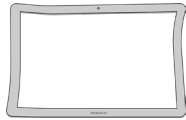

Display frame

Al
Aluminum

20. Remove the camera with logic board.

» Unscrew the three Phillips fasteners.

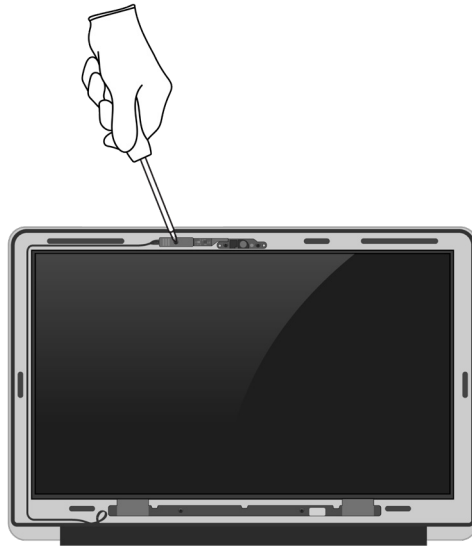

Tools Used

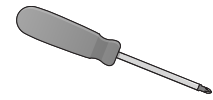

Fraction



Fasteners (x3)

Fe

Ferrous

» Pull off the camera with logic board and the attached camera cable. Set the display aside.



21. Cut the camera with logic board off the camera cable.

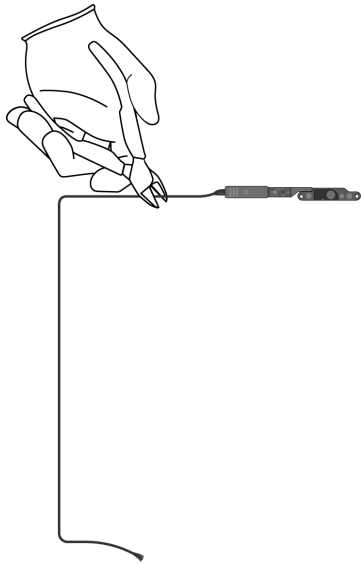

Tools Used

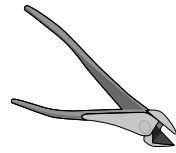

Fraction



Camera cable

Cu

Copper

Fraction



Camera with
logic board

PMs

Precious
Metals

22. On the display, pull off the antenna cover.

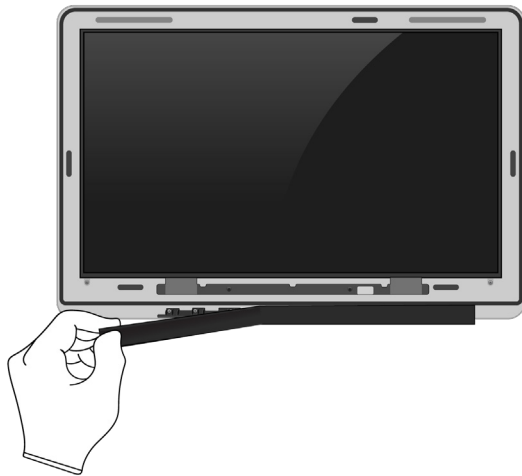

Fraction



Antenna cover

PL
Plastics

23. Remove the antenna by unscrewing the nine Phillips fasteners.

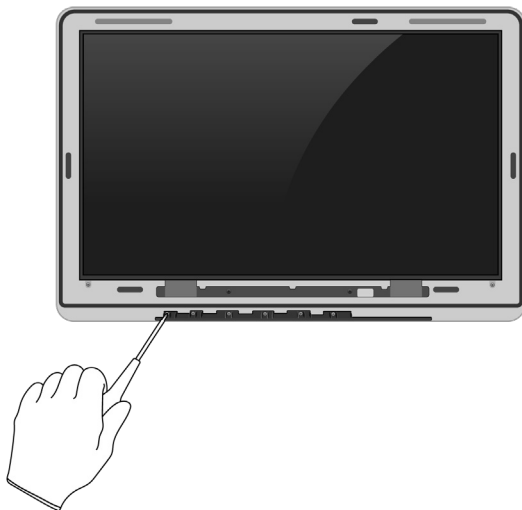

Tools Used



Fraction



Fasteners (x9)

Fe
Ferrous

Fraction



Antenna

Cu
Copper

24. Pry off the data board assembly.

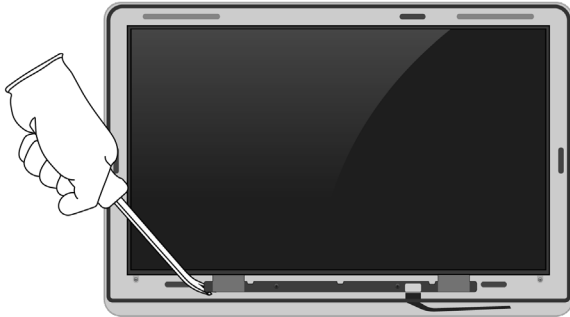

Tools Used

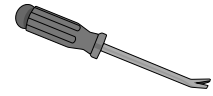

Fraction



Data board assembly



25. Remove the LCD cell and display films.



Broken glass hazard



Chemical exposure hazard

» Unscrew the five Phillips fasteners.

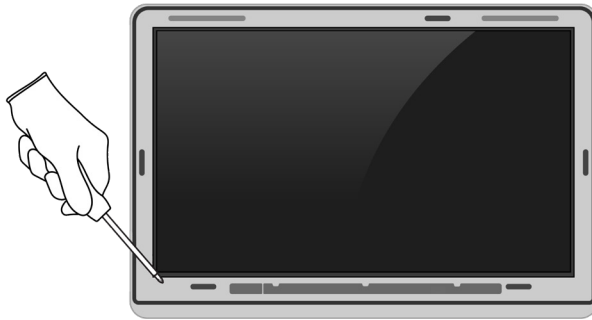

» Pry off the LCD cell and display films.



Tools Used

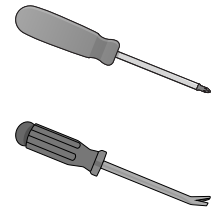

Fraction



Fasteners (x5)

Fe

Ferrous

Fraction

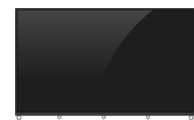

LCD cell

GL

Glass

Fraction

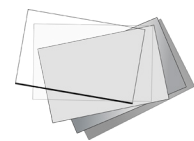

Display films

PL

Plastics

26. Pry off the LED logic board.



Chemical inhalation hazard

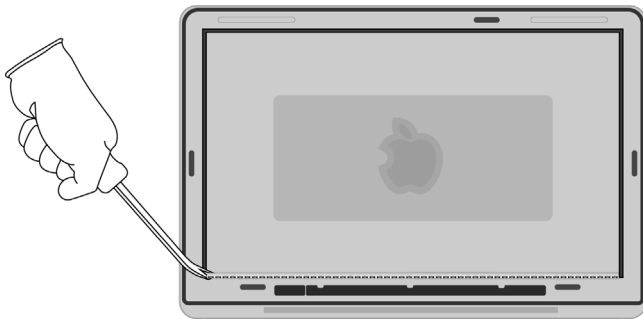

Tools Used

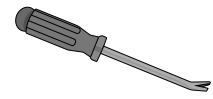

Fraction

LED logic board





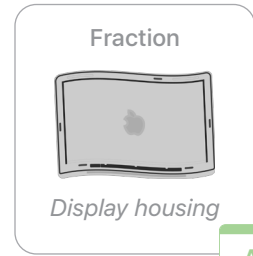
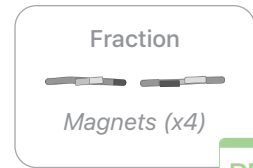
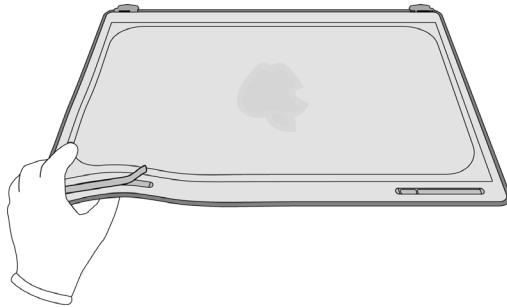



27. Bend the display housing until the four magnets pop up. Pull off the magnets.



Material Categorization of Output Fractions

All outputs from this process must be managed, handled, and disposed of in accordance with applicable waste laws and regulations, including but not limited to the Waste Framework Directive and its national enactments in Europe.

Fraction	Downstream Processing
<p>Aluminum</p>  <p><i>Bottom case</i></p>  <p><i>Trackpad plate</i></p>  <p><i>Trackpad enclosure</i></p>  <p><i>Display frame</i></p>  <p><i>Display housing</i></p>	<p>Primary Target Material</p>  <p>Potential Additional Materials</p> 

Fraction

Downstream Processing

Batteries



Lithium-ion polymer batteries (x4)

Primary Target Material



Ferrous

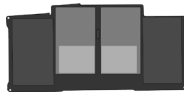

Battery heat shield

Primary Target Material



Fasteners (x27)

Glass

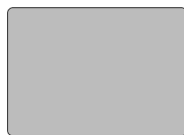

Trackpad

Primary Target Material

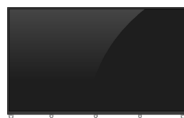

LCD cell

Potential Additional Materials



Fraction

Downstream Processing

Logic Boards



Power supply logic board



Trackpad logic board



Main logic board



Keyboard



Camera with logic board



Data board assembly



LED logic board

Primary Target Material



Potential Additional Materials



Fraction

Downstream Processing

Mixed Electronics

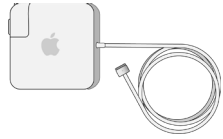

Power adapter and charge cable



Power supply cables

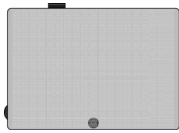

Sensor protective film

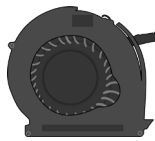

Fan

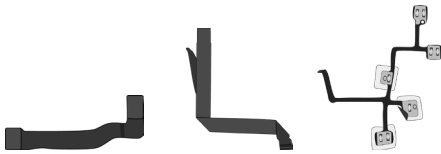

Ribbon cables



Camera cable



Antenna

Primary Target Material



Potential Additional Materials



Fraction

Downstream Processing

Mixed Plastics



Thermal duct



Keyboard sheet



Antenna cover

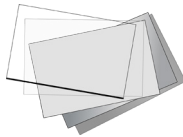

Display films

Primary Target Material



Rare Earth Magnets

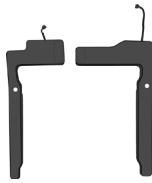

Speakers



Magnets (x4)

Primary Target Material



Potential Additional Materials

