



MacBook Pro (14-inch, 2021)

MacBook Pro (16-inch, 2021)

Apple Recycler Guide

July 2023

Contents

- 3 [About This Guide](#)
- 4 [Identification](#)
- 5 [Directive 2021/19/EU Annex VII Components](#)
- 6 [Safety Considerations](#)
- 8 [Recommended Tools](#)
- 9 [Disassembly Instructions](#)
- 20 [Material Categorization of Output Fractions](#)

About This Guide

Apple Recycler Guides provide guidance for electronics recyclers on how to disassemble products to maximize recovery of resources. The guides provide step-by-step disassembly instructions and information on the material composition to help recyclers direct fractions to the appropriate material recycler.

To conserve important resources, we work to reduce the materials we use and aim to one day source only recycled or renewable materials in our products. A key path to reaching that goal is resource recovery from end-of-life electronics.

Disassembly procedures are intended to be performed only by trained electronics recycling professionals. The recycler is responsible for independently evaluating and ensuring compliance with all applicable environmental, health, and safety laws related to the work. These include but are not limited to laws relating to the management, handling, shipping, and disposal of the outputs of this work as waste and laws in place to ensure the health and safety of all employees who support this work.

For questions or feedback about this guide, email contactesci@apple.com.

Note: This guide may show images from other similar models, but the procedures are the same.

Identification

You can find the model number on the underside of the MacBook Pro, near the regulatory markings.

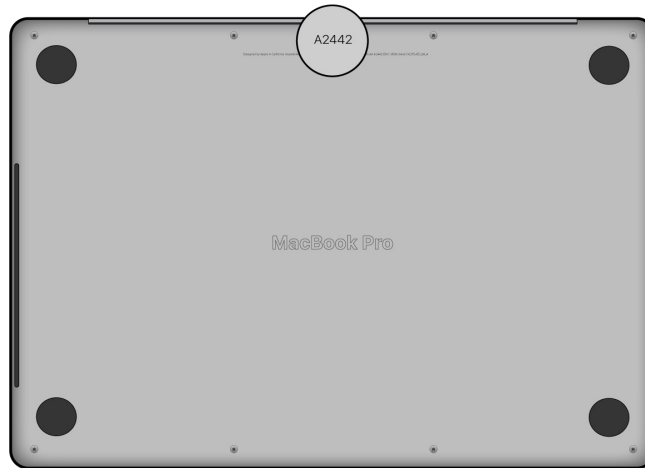

Model numbers:
A2442, A2485

Directive 2012/19/EU Annex VII Components

Directive 2012/19/EU Annex VII requirements apply to the following substances and components.

| Substance/Component | Apple Part Name | Removal Instructions |
|---|---|-----------------------------|
| Printed circuit board if the surface is greater than 10 square centimeters | Main logic board, data board assembly, trackpad, and light-emitting diode (LED) array | Follow steps 1–14 |
| External electric cables | Charge cable | Follow step 1 |
| Battery | Lithium-ion polymer batteries | Follow steps 1–3 |
| Cover glass and liquid crystal display (LCD) cell if the surface is greater than 100 square centimeters | Display | Follow steps 1–12 |
| No further substances or components as listed in Annex VII | | |

Safety Considerations

The recycler is responsible for independently evaluating all activities undertaken by its employees to perform or support the work and ensuring compliance with all applicable health and safety laws related to the work. These include but are not limited to laws relating to the health and safety of all employees who perform or support this work. The recycler is also responsible for evaluating the workspace and ensuring that the area in which the work is to be undertaken is designed using ergonomic best practices and meets all ergonomic requirements to ensure the protection of its employees.

Personal Protective Equipment

Personal protective equipment should be worn during the entire recycling process.



Wear hand protection



Wear foot protection



Wear eye protection



Wear a mask



Wear protective clothing

Battery Safety

This product uses a lithium-ion polymer battery. Before beginning any disassembly work, ensure that a safe working procedure for handling lithium-ion batteries has been established, which could include discharging the batteries so that they can be more safely managed. The following considerations may also be included:

- Remove anything from your person that could conduct energy, such as jewelry and watches, to avoid electric shock to yourself or the logic board.
- To avoid thermal runaway and the release of noxious fumes, don't puncture, strike, or crush lithium-ion polymer batteries or devices powered by them.
- Don't throw, drop, or bend the battery.
- Don't expose the battery to excessive heat or sunlight.
- Don't use tools that are sharp or conduct electricity.
- Keep your workspace clear of foreign objects and sharp materials.
- Dispose of batteries according to local environmental laws and guidelines.

Workspace safety guidelines

- Use heat-resistant gloves and safety glasses.
- Keep a sand dispenser within arm's reach (2 feet or 0.6 m) on one side of the workstation, not above the workstation. The dispenser should be a wide-mouthed, quick-pour metal container with a flip-top lid or tray that contains 8–10 cups (1.9–2.4 L) of clean, dry, untreated sand.
- Keep the battery at least 2 feet (0.6 m) from paper and other combustible materials.
- Work in an area with adequate ventilation.

Handling a thermal runaway

If you notice any of the following signs, a thermal runaway is likely underway, and you should act immediately:

- The lithium-ion polymer battery or a device containing one begins to smoke or emit sparks or soot.
- The battery pouch suddenly and quickly puffs out.
- You hear hissing or popping sounds.

Don't use water or an ABC/CO₂ fire extinguisher on a thermal runaway battery or a device containing one. Water and ABC/CO₂ fire extinguishers will not stop the reaction.

Do smother the battery or device immediately with plenty of clean, dry sand, dumped all at once. Timing is critical; the faster you pour all the sand, the faster the thermal runaway will stop.

Do leave the room for 30 minutes if the thermal runaway causes any irritation.

Do wait 30 minutes before touching the battery. Wear heat-resistant gloves and safety glasses to remove the battery from the sand, or use a touchless thermometer to measure the battery temperature. Only touch the battery when the event has finished.

Do dispose of the damaged battery or device (including any debris removed from the sand) according to local environmental laws and guidelines.

Hazard Warnings



Rechargeable battery hazard



Chemical exposure hazard



Broken glass hazard



Chemical inhalation hazard



Sharp edges—cut hazard

Recommended Tools

Miniature pry bar

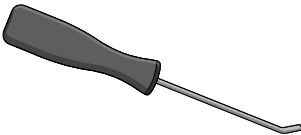

Nail-pulling screwdriver

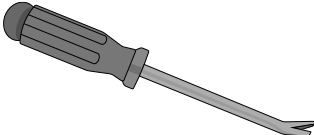

Plastic pry bar

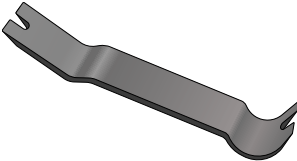

Screwdriver-handle pry bar

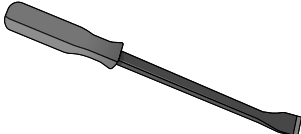

Torx T5 screwdriver

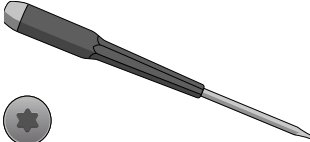

Disassembly Instructions

1. Remove the power adapter and the charge cable.

- » *Ensure that the MacBook Pro is turned off.*
- » *Unplug the power adapter. Disconnect the charge cable.*

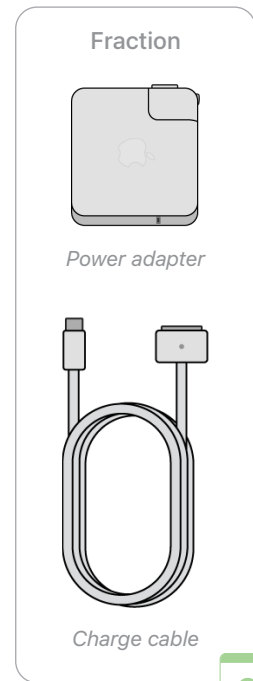
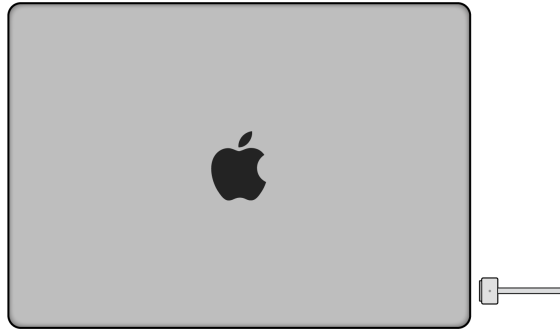

2. Carefully pry off the bottom case near the fasteners to avoid damage to the batteries.

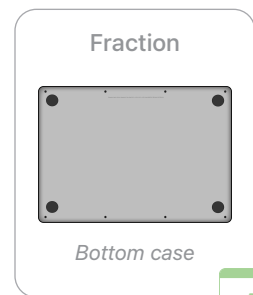
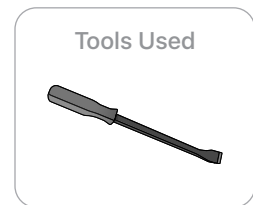
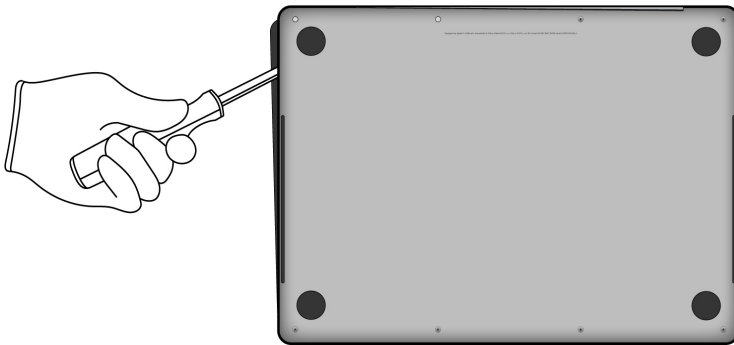

3. From the top case, carefully remove the six lithium-ion polymer batteries.

 Rechargeable battery hazard

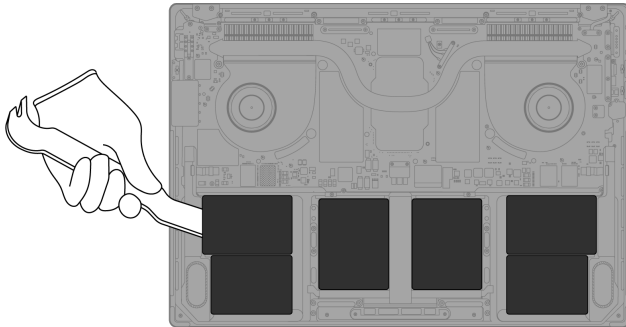

Tools Used



Fraction



Lithium-ion polymer batteries (x6)

BT
Battery

4. Pry off the power supply logic board.

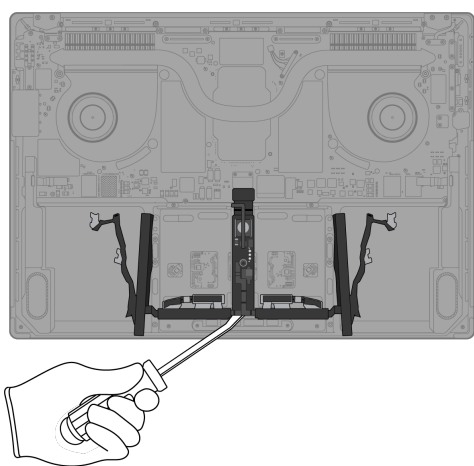

Tools Used



Fraction



Power supply logic board

PMs
Precious Metals

5. Pry off both speakers.

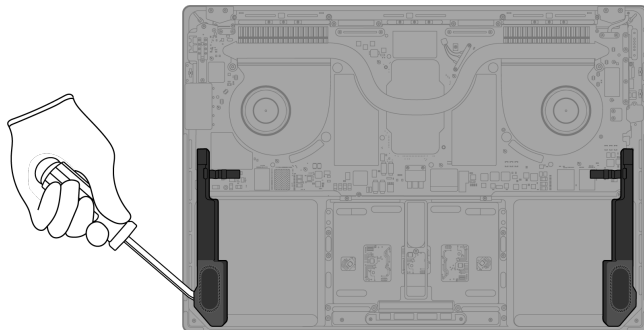

Tools Used

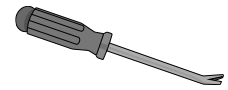

Fraction



Speakers (x2)

REE

Rare Earth
Elements

6. Remove the two thermal ducts.

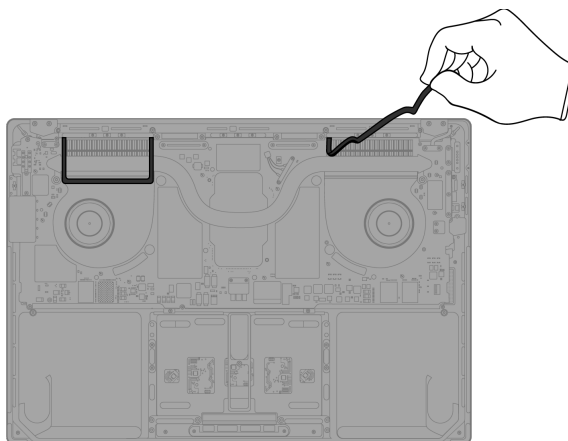

Fraction



Thermal ducts (x2)

PL

Plastics

7. Pry off the main logic board.

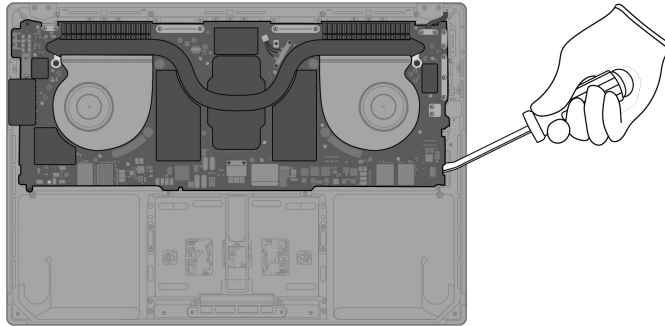

Tools Used

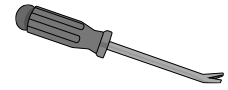

Fraction

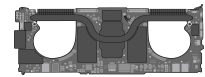

Main logic board

PMs
Precious Metals

8. Pry off both fans.

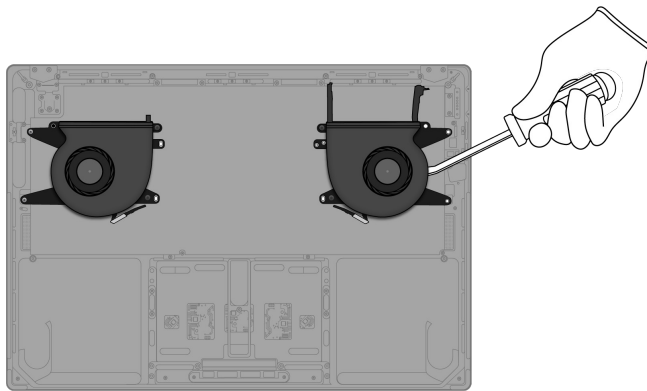

Tools Used

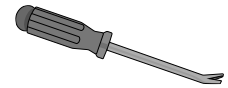

Fraction

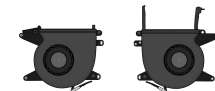

Fans

Cu
Copper

9. Remove the trackpad by unscrewing the 10 Torx T5 fasteners.

 Broken glass hazard

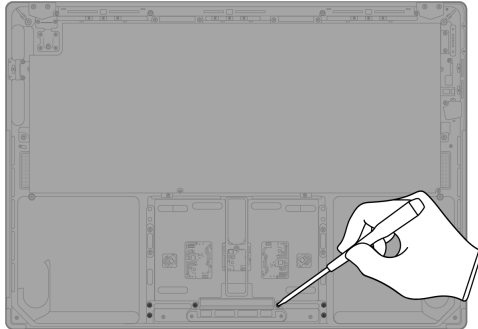

Tools Used



Fraction



Fasteners (x10)

Fe
Ferrous

Fraction



Trackpad

PMs
Precious Metals

10. Separate the display and top case by bending them back and forth until the hinges break.



Sharp edges—cut hazard

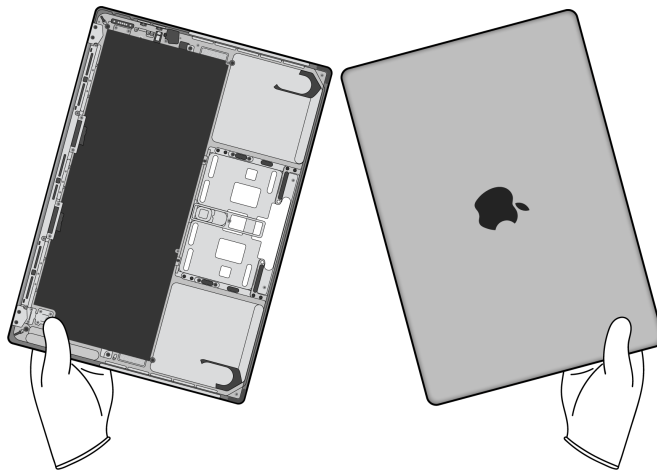
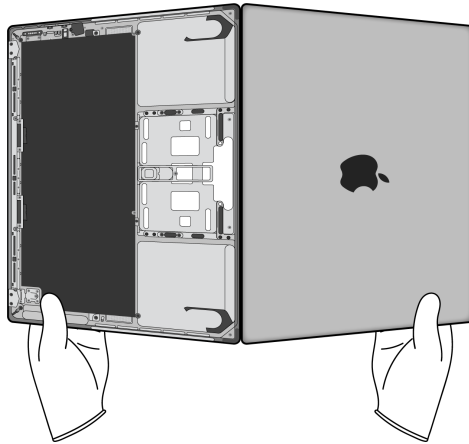

Fraction

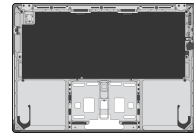

Top case

Cu

Copper

11. Pull off the display gasket by hand.

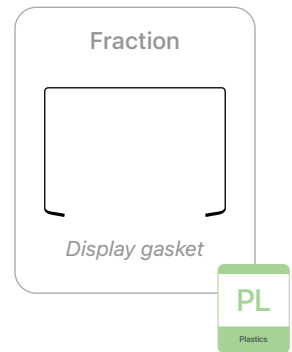

12. Pry away the LCD cell and display films from the display housing.



Broken glass hazard



Chemical exposure hazard



Tools Used



Fraction



LCD cell

GL

Glass

Fraction



Display films

PL

Plastics

13. Pry off the data board assembly.

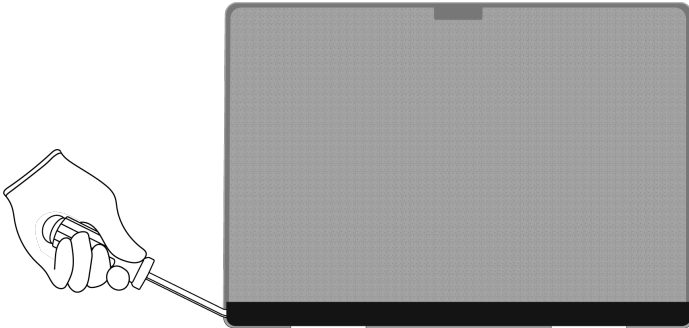

Tools Used

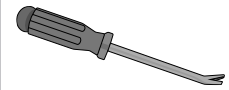

Fraction



Data board assembly



14. Pry off the LED array.



Chemical inhalation hazard

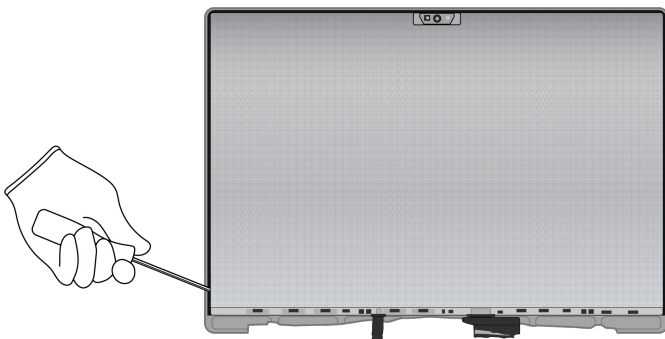

Tools Used



Fraction

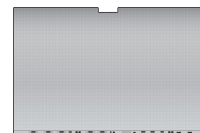

LED array



15. Pull off the ribbon cable.

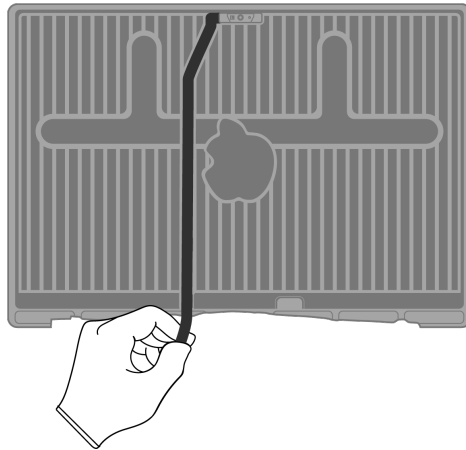

Fraction

Ribbon cable

Cu
Copper

A diagram showing a black ribbon cable with a fraction bar above it. Below the cable is the text "Ribbon cable". To the right is a green box containing the chemical symbol "Cu" and the word "Copper" below it.

16. Pry off the camera.

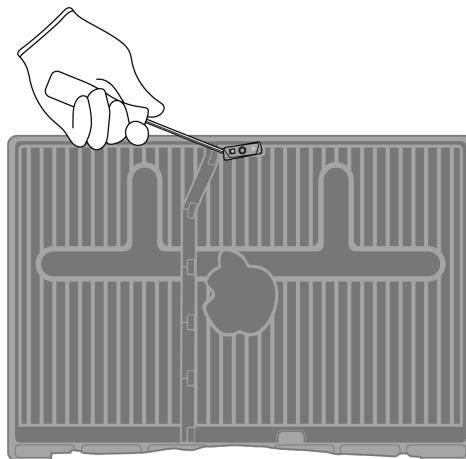

Tools Used

A simple line drawing of a screwdriver with a black handle and a metal shaft.

Fraction

Camera

PMs
Precious Metals

A diagram showing a small rectangular camera component with a fraction bar above it. Below the camera is the text "Camera". To the right is a green box containing the chemical symbol "PMs" and the words "Precious Metals" below it.

17. Remove the six magnets.

» Bend the display housing until the magnets pop up.

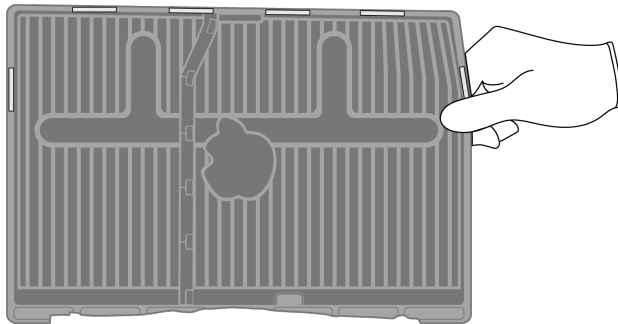

Tools Used



Fraction



Magnets (x6)

REE
Rare Earth
Elements

» Pry off the magnets.

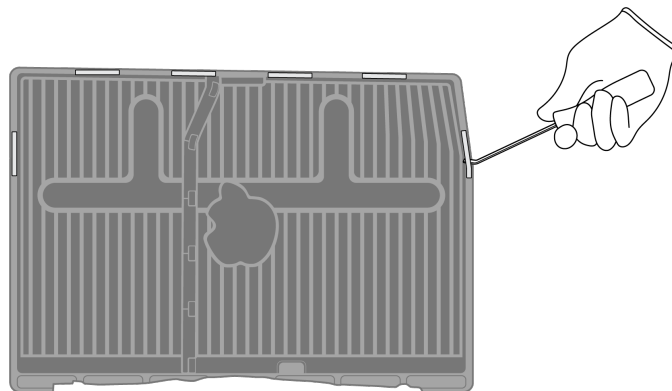

Fraction

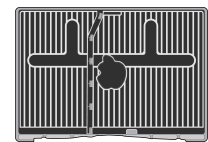







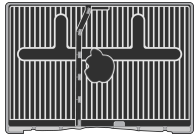

Display housing

Al
Aluminum

Material Categorization of Output Fractions

All outputs from this process must be managed, handled, and disposed of in accordance with applicable waste laws and regulations, including but not limited to the Waste Framework Directive and its national enactments in Europe.

| Fraction | Downstream Processing |
|---|--|
| <p data-bbox="435 604 570 632">Aluminum</p>  <p data-bbox="440 831 561 852"><i>Bottom case</i></p>  <p data-bbox="423 1052 574 1073"><i>Display housing</i></p> | <p data-bbox="964 604 1276 632">Primary Target Material</p>  <p data-bbox="927 831 1313 858">Potential Additional Materials</p>   |
| <p data-bbox="440 1171 565 1199">Batteries</p>  <p data-bbox="337 1413 667 1434"><i>Lithium-ion polymer batteries (x6)</i></p> | <p data-bbox="964 1171 1276 1199">Primary Target Material</p>  |
| <p data-bbox="448 1528 553 1556">Ferrous</p>  <p data-bbox="423 1703 574 1724"><i>Fasteners (x10)</i></p> | <p data-bbox="964 1528 1276 1556">Primary Target Material</p>  |

Fraction

Downstream Processing

Glass



LCD cell

Primary Target Material



Potential Additional Materials



Logic Boards



Power supply logic board

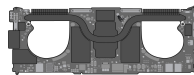

Main logic board



Trackpad



Data board assembly

Primary Target Material



Potential Additional Materials



Logic Boards (cont.)

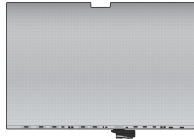

LED array

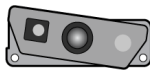

Camera

Mixed Electronics

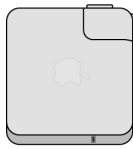

Power adapter

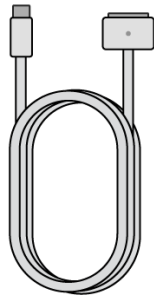

Charge cable



Fans

Primary Target Material



Potential Additional Materials



Fraction

Downstream Processing

Mixed Electronics (cont.)



Ribbon cable

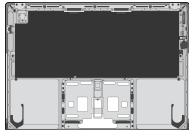

Top case

Mixed Plastics



Thermal ducts (x2)



Display gasket



Display films

Primary Target Material



Fraction

Downstream Processing

Rare Earth Magnets



Speakers (x2)



Magnets (x6)

Primary Target Material



Potential Additional Materials

