



**MacBook Pro (15-inch, 2016)**

**MacBook Pro (15-inch, 2017)**

**MacBook Pro (15-inch, 2018)**

**MacBook Pro (15-inch, 2019)**

## **Apple Recycler Guide**

July 2023

# Contents

3	<a href="#">About This Guide</a>
4	<a href="#">Identification</a>
5	<a href="#">Directive 2012/19/EU Annex VII Components</a>
6	<a href="#">Safety Considerations</a>
9	<a href="#">Recommended Tools</a>
10	<a href="#">Disassembly Instructions</a>
26	<a href="#">Material Categorization of Output Fractions</a>

# About This Guide

Apple Recycler Guides provide guidance for electronics recyclers on how to disassemble products to maximize recovery of resources. The guides provide step-by-step disassembly instructions and information on the material composition to help recyclers direct fractions to the appropriate material recycler.

To conserve important resources, we work to reduce the materials we use and aim to one day source only recycled or renewable materials in our products. A key path to reaching that goal is resource recovery from end-of-life electronics.

Disassembly procedures are intended to be performed only by trained electronics recycling professionals. The recycler is responsible for independently evaluating and ensuring compliance with all applicable environmental, health, and safety laws related to the work. These include but are not limited to laws relating to the management, handling, shipping, and disposal of the outputs of this work as waste and laws in place to ensure the health and safety of all employees who support this work.

For questions or feedback about this guide, email [contactesci@apple.com](mailto:contactesci@apple.com).

**Note:** This guide may show images from other similar models, but the procedures are the same.

# Identification

You can find the model number printed on the underside of the MacBook Pro, near the regulatory markings.

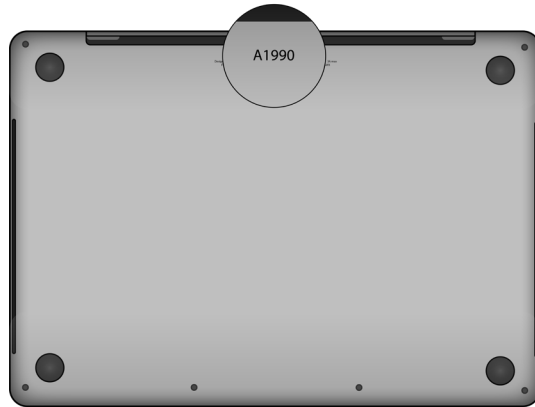

*Model numbers:*  
A1707, A1990

# Directive 2012/19/EU Annex VII Components

Directive 2012/19/EU Annex VII requirements apply to the following substances and components.

Substance/Component	Apple Part Name	Removal Instructions
Printed circuit board if the surface is greater than 10 square centimeters	Main logic board, trackpad, keyboard, data board assembly, light-emitting diode (LED) logic board	Follow steps 1–22
External electric cables	Charge cable, power cord	Follow step 1
Battery	Lithium-ion batteries	Follow steps 1–3
Cover glass and liquid crystal display (LCD) cell if the surface is greater than 100 square centimeters	LCD cell	Follow steps 1–14
No further substances or components as listed in Annex VII		

# Safety Considerations

The recycler is responsible for independently evaluating all activities undertaken by its employees to perform or support the work and ensuring compliance with all applicable health and safety laws related to the work. These include but are not limited to laws relating to the health and safety of all employees who perform or support this work. The recycler is also responsible for evaluating the workspace and ensuring that the area in which the work is to be undertaken is designed using ergonomic best practices and meets all ergonomic requirements to ensure the protection of its employees.

## Personal Protective Equipment

Personal protective equipment should be worn during the entire recycling process.



Wear hand protection



Wear protective clothing



Wear eye protection



Wear foot protection



Wear a mask

## Battery Safety

This product uses a lithium-ion polymer battery. Before beginning any disassembly work, ensure that a safe working procedure for handling lithium-ion batteries has been established, which could include discharging the batteries so that they can be more safely managed. The following considerations may also be included:

- Remove anything from your person that could conduct energy, such as jewelry and watches, to avoid electric shock to yourself or the logic board.
- To avoid the potential for thermal runaway and the release of potentially noxious fumes, don't puncture, strike, or crush lithium-ion polymer batteries or devices powered by them.
- Don't throw, drop, or bend the battery.
- Don't expose the battery to excessive heat or sunlight.
- Don't use tools that are sharp or conduct electricity.
- Keep your workspace clear of foreign objects and sharp materials.
- Dispose of batteries according to local environmental laws and guidelines.

## Workspace safety guidelines

- Use heat-resistant gloves and safety glasses.
- Keep a sand dispenser within arm's reach (2 feet or 0.6 m) on one side of the workstation, not above the workstation. The dispenser should be a wide-mouthed, quick-pour metal container with a flip-top lid or tray that contains 8–10 cups (1.9–2.4 L) of clean, dry, untreated sand.
- Keep the battery at least 2 feet (0.6 m) from paper and other combustible materials.
- Work in an area with adequate ventilation.

## Handling a thermal runaway

If you notice any of the following signs, a thermal runaway is likely underway, and you should act immediately:

- The lithium-ion polymer battery or a device containing one begins to smoke or emit sparks or soot.
- The battery pouch suddenly and quickly puffs out.
- You hear hissing or popping sounds.

**Don't** use water or an ABC/CO<sub>2</sub> fire extinguisher on a thermal runaway battery or a device containing one. Water and ABC/CO<sub>2</sub> fire extinguishers will not stop the reaction.

**Do** smother the battery or device immediately with plenty of clean, dry sand, dumped all at once. Timing is critical; the faster you pour all the sand, the faster the thermal runaway will stop.

**Do** leave the room for 30 minutes if the thermal runaway causes any irritation.

**Do** wait 30 minutes before touching the battery. Wear heat-resistant gloves and safety glasses to remove the battery from the sand, or use a touchless thermometer to measure the battery temperature. Only touch the battery when the event has finished.

**Do** dispose of the damaged battery or device (including any debris removed from the sand) according to local environmental laws and guidelines.

## LED Safety

Broken light-emitting diodes (LEDs) must be handled properly to ensure the safety of your employees and mitigate any hazards. Package broken LEDs in an appropriate container to properly manage the hazards associated with the materials and store only with compatible materials. All waste must be properly classified, packaged, and labeled in accordance with all relevant laws and regulations.

## Hazard Warnings



Rechargeable battery hazard



Chemical exposure hazard



Broken glass hazard



Chemical inhalation hazard



# Recommended Tools

Flat surface scraper

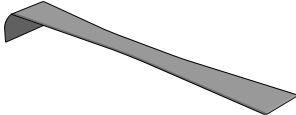

Miniature pry bar

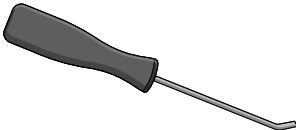

Nail-pulling screwdriver

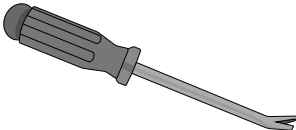

Plastic pry bar

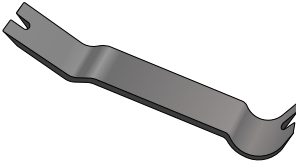

Torx T2 screwdriver

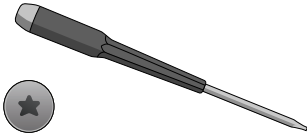

Torx T5 screwdriver

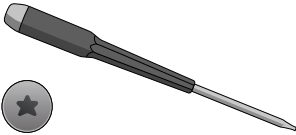

# Disassembly Instructions

## 1. Remove the power adapter and the charge cable.

» *Ensure that the iPad Pro is turned off.*



» *Unplug and remove the power adapter and charge cable.*

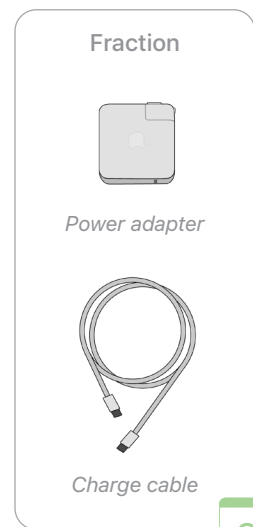
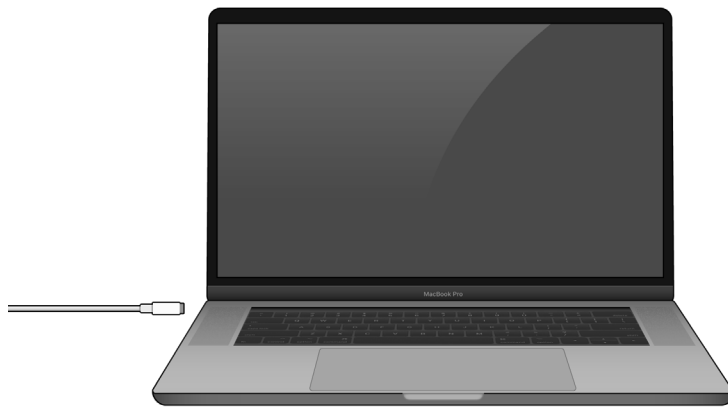

2. Pry off the bottom case. To avoid damage to the batteries, pry only near the fastener attachments.

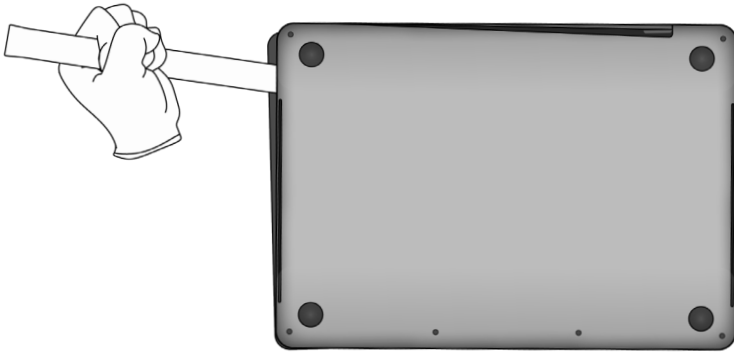

Tools Used

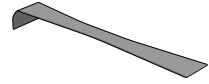

Fraction



Bottom case

Al

Aluminum

3. From the top case, carefully remove the six lithium-ion polymer batteries.



Rechargeable battery hazard

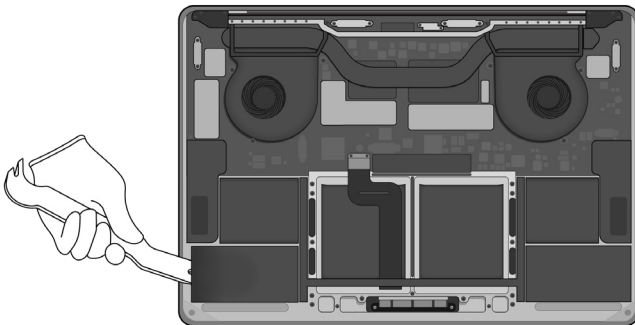

Tools Used

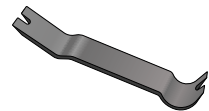

Fraction



Lithium-ion polymer  
batteries

BT

Battery

4. Pull off the battery cables.

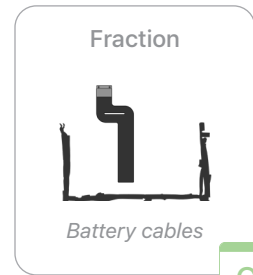
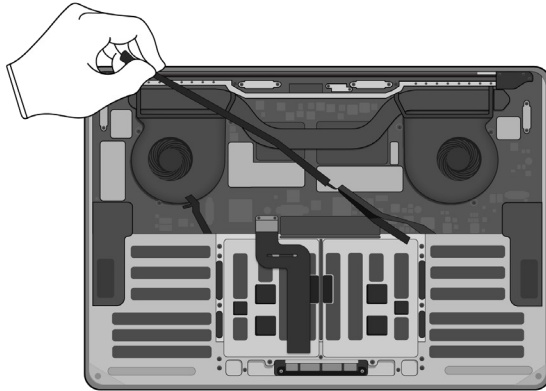

**Cu**  
Copper

5. Pry off both speakers.

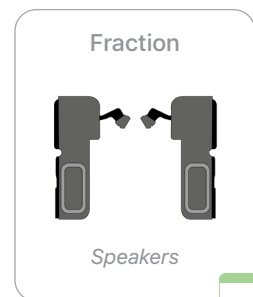
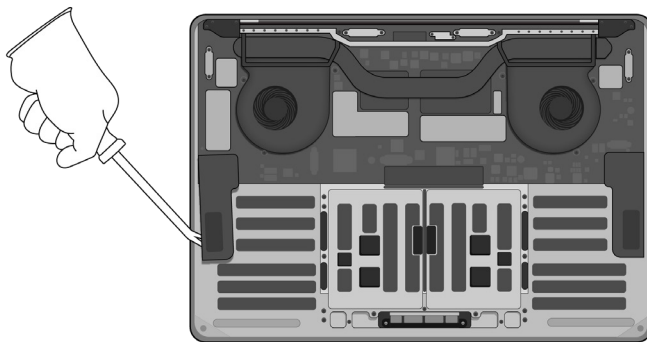

**REE**  
Rare Earth Elements

6. Remove the thermal ducts sitting on top of the fans.

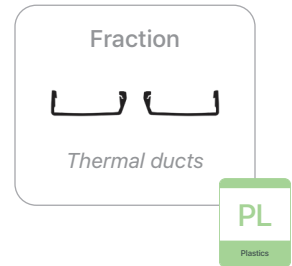
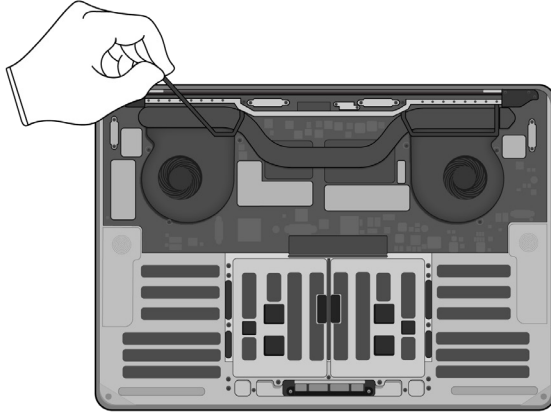

7. Pry off the main logic board.

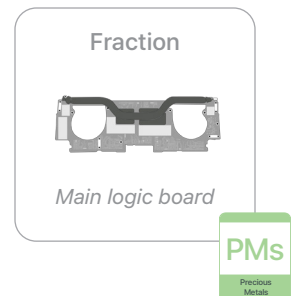
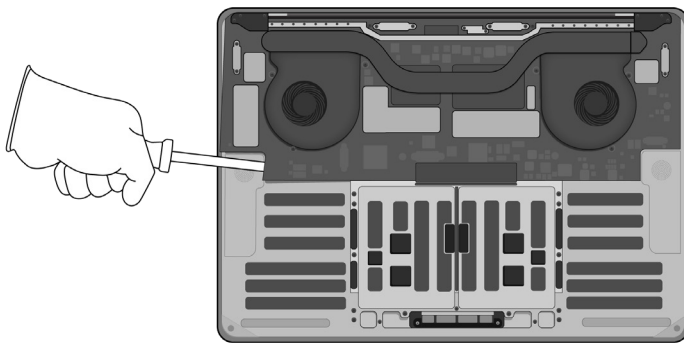

8. Pry off the battery logic board.

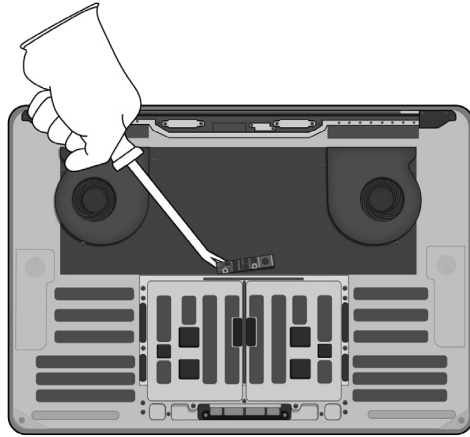

Tools Used

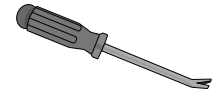

Fraction



Battery logic board

PMs  
Precious Metals

9. Pry off both fans.

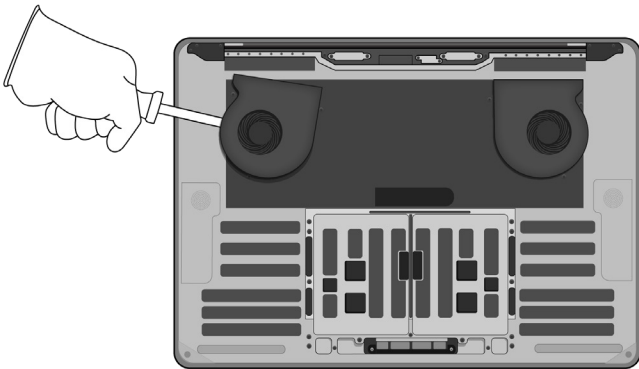

Tools Used

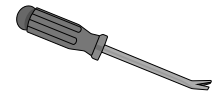

Fraction

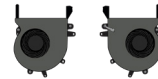

Fans

Cu  
Copper

**10.** Remove the trackpad by unscrewing the 13 Torx T5 fasteners.

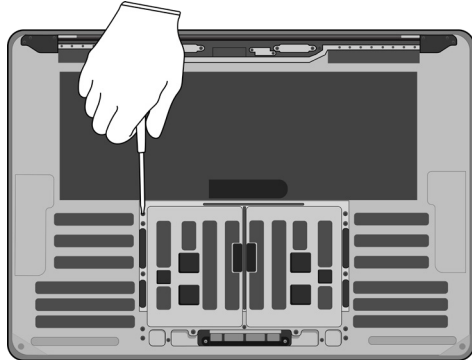

Tools Used

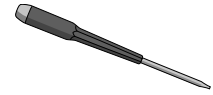

Fraction



Fasteners (x13)

Fe

Ferrous

Fraction



Trackpad

PMs

Precious Metals

11. Separate the display and top case by bending them back and forth at the hinge until they break in two. Set the display aside.

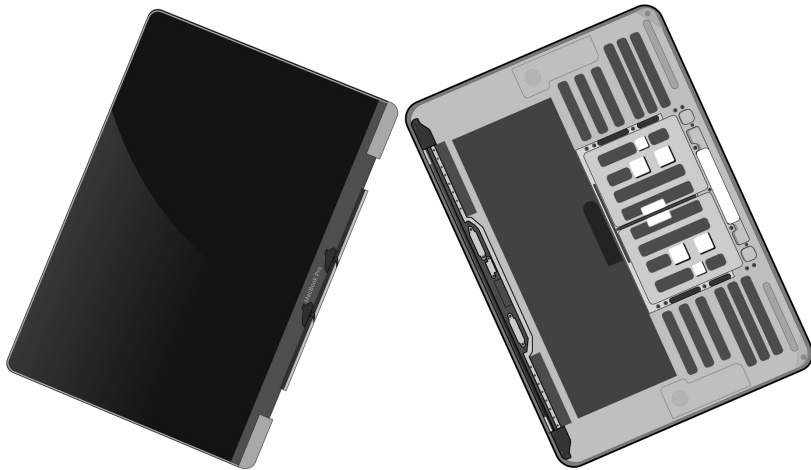
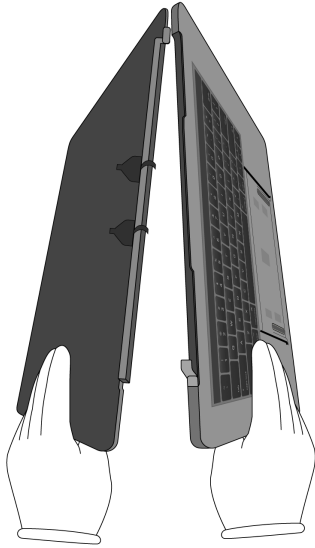



12. Separate the keyboard and trackpad enclosure by snapping the top case in half.

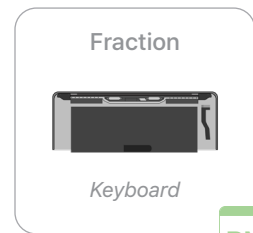
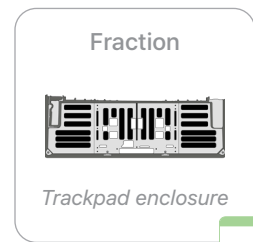
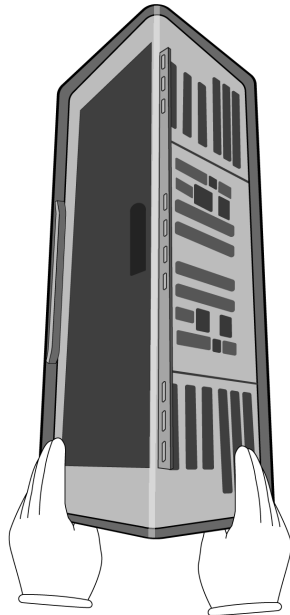

### 13. Pull off the display gasket.

 Broken glass hazard

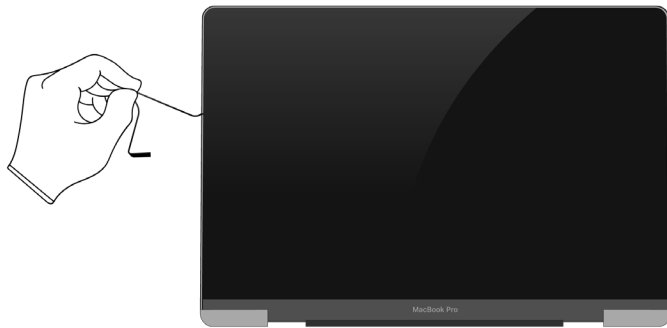

Fraction



Display gasket

PL  
Plastics

**14.** Pry away the LCD cell and display films from the display housing.

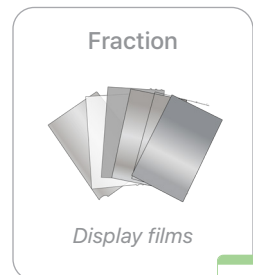
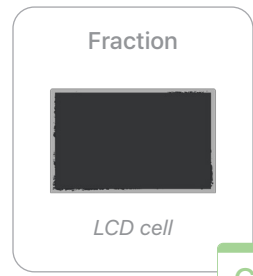
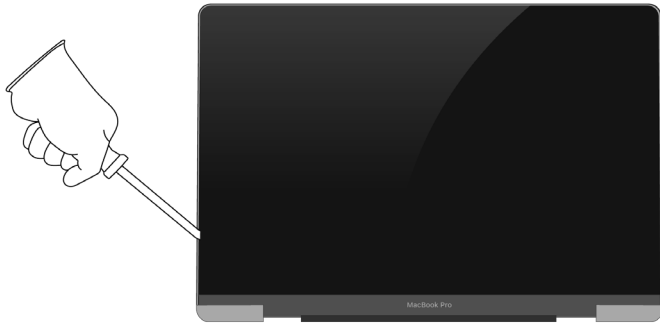
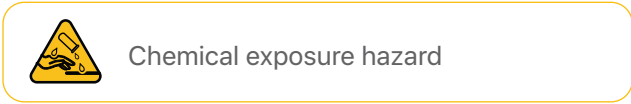

**15.** Remove the plastic sheet from the display housing.

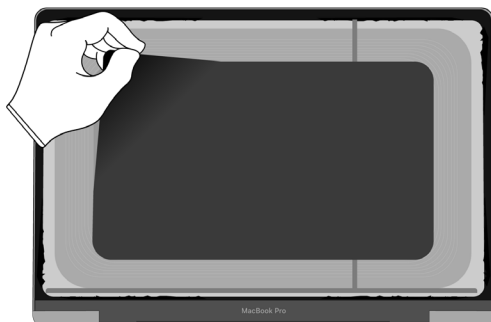

## 16. Remove the camera with logic board.

» *Unscrew the three Torx T2 fasteners.*

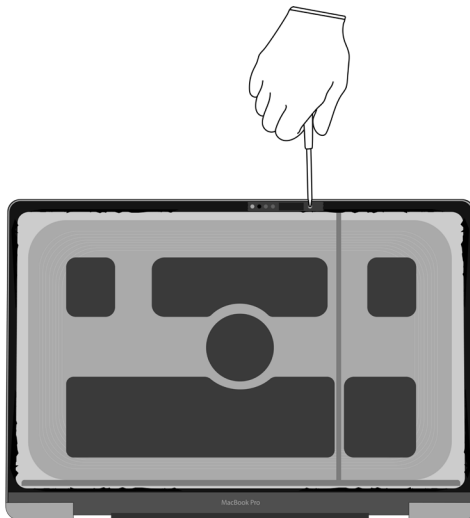
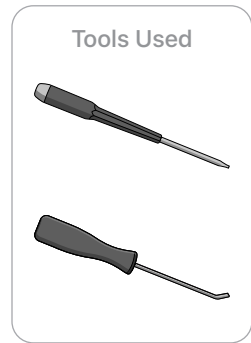
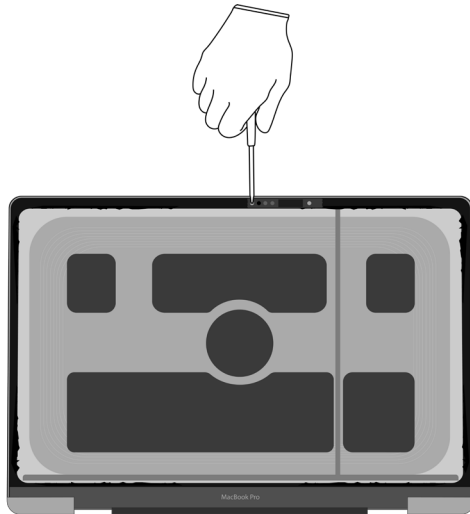

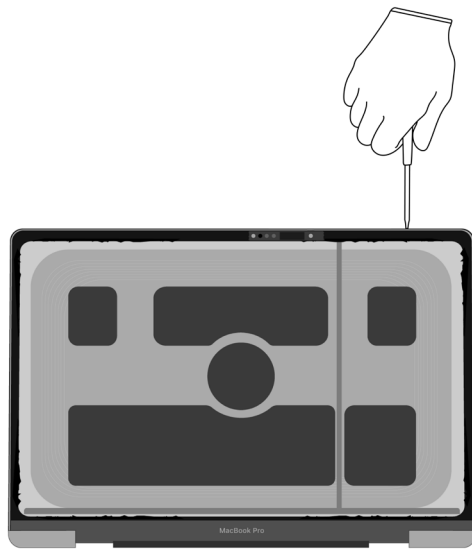

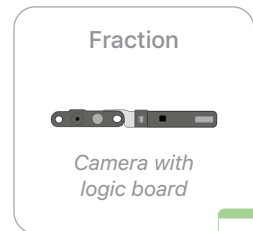
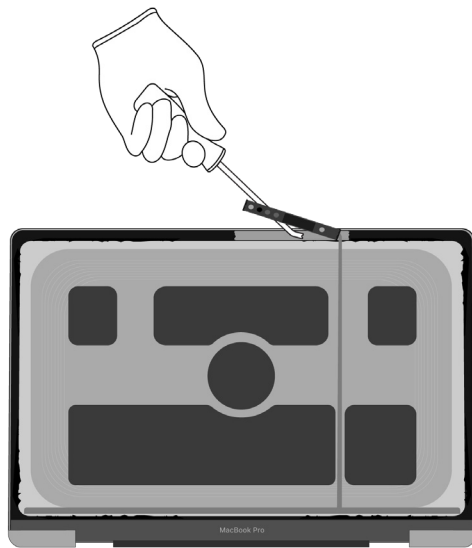

» *Pry the camera with logic board off the display housing.*

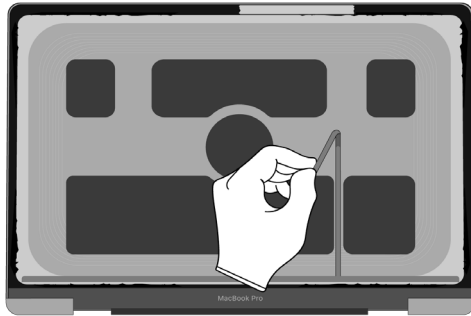

- 17.** Remove the LED/camera wire leading to the LED logic board.



Fraction



LED/camera wire

**Cu**  
Copper

- 18.** Pry off the data board assembly.

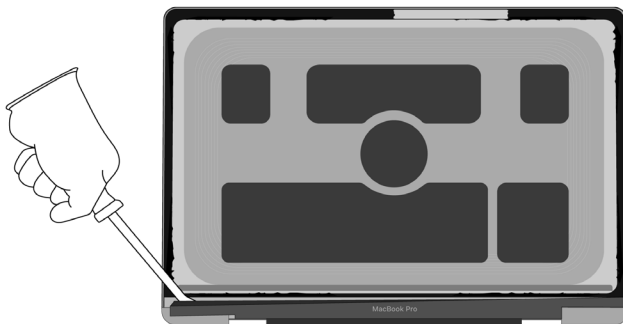

Tools Used

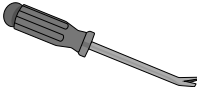

Fraction



Data board assembly

**PMs**  
Precious Metals

**19.** Pry off the plastic bracket.

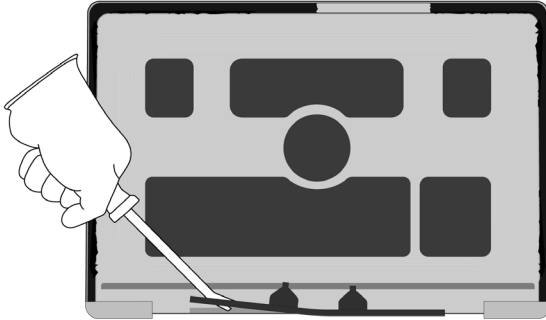

Tools Used

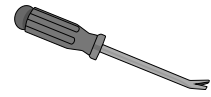

Fraction



*Plastic bracket*

PL

Plastics

**20.** Pry off the cable bracket.

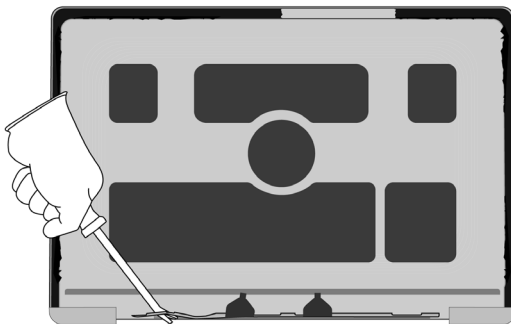

Tools Used

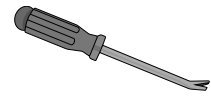

**21.** Pull the ribbon cables off the cable bracket.

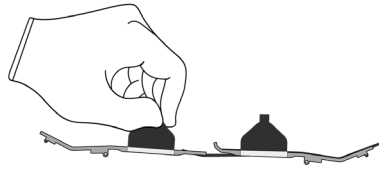

Fraction



Cable bracket

**Fe**  
Ferrous

Fraction



Ribbon cables

**Cu**  
Copper

**22.** Pull the LED logic board off the display housing.  
Pull the ribbon cables off the LED logic board.



Chemical inhalation hazard

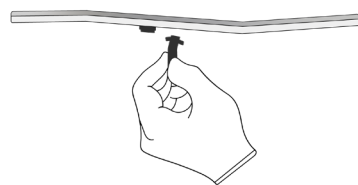
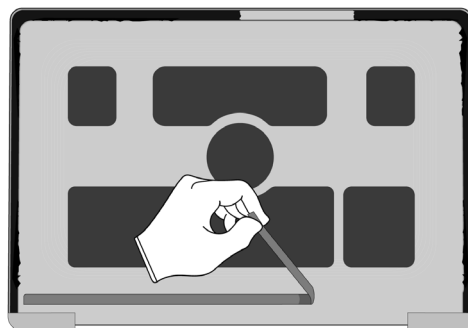

Fraction



Ribbon cables

**Cu**  
Copper

Fraction



LED logic board

**PMs**  
Precious Metals



## 23. Remove the four magnets.

» Bend the display housing to pop up the four magnets.

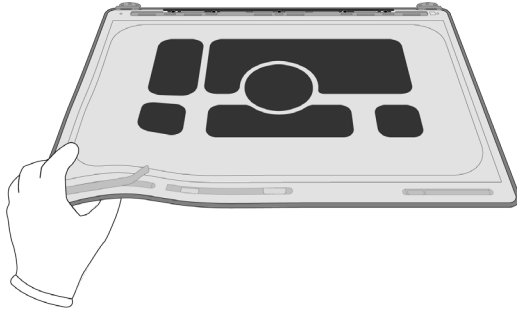

» Pry off the magnets.

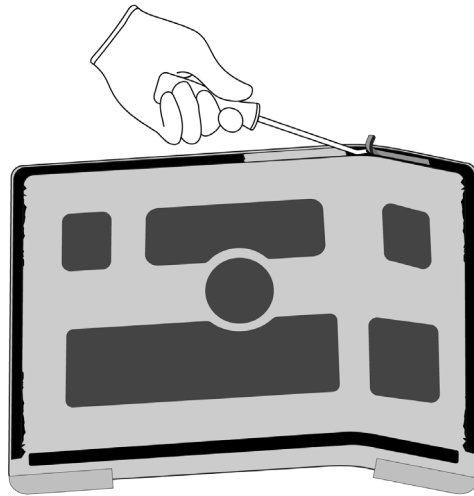

### Tools Used



### Fraction



Display housing

Al

Aluminum

### Fraction

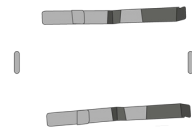







Magnets

REE

Rare Earth Elements

# Material Categorization of Output Fractions

All outputs from this process must be managed, handled, and disposed of in accordance with applicable waste laws and regulations, including but not limited to the Waste Framework Directive and its national enactments in Europe.

Fraction	Downstream Processing
<p data-bbox="435 604 570 636"><b>Aluminum</b></p>  <p data-bbox="440 810 565 831"><i>Bottom case</i></p>  <p data-bbox="407 968 592 989"><i>Trackpad enclosure</i></p>  <p data-bbox="423 1167 576 1188"><i>Display housing</i></p>	<p data-bbox="964 604 1276 636"><b>Primary Target Material</b></p>  <p data-bbox="924 856 1317 888"><b>Potential Additional Materials</b></p> 
<p data-bbox="440 1287 565 1318"><b>Batteries</b></p>  <p data-bbox="358 1440 641 1461"><i>Lithium-ion polymer batteries</i></p>	<p data-bbox="964 1287 1276 1318"><b>Primary Target Material</b></p> 

**Fraction** **Downstream Processing**

**Ferrous**



*Fasteners (x16)*



*Cable bracket*

**Primary Target Material**



**Glass**



*LCD cell*

**Primary Target Material**



**Potential Additional Materials**



## Fraction

## Downstream Processing

### Logic Boards



*Main logic board*



*Battery logic board*



*Trackpad*



*Keyboard*



*Camera with logic board*



*Data board assembly*



*LED logic board*

### Primary Target Material



### Potential Additional Materials



**Fraction**

**Downstream Processing**

**Mixed Electronics**



*Power adapter*



*Charge cable*



*Battery cables*



*Fans*



*LED/camera wire*



*Ribbon cables*

**Primary Target Material**



**Potential Additional Materials**



**Fraction**

**Downstream Processing**

**Mixed Plastics**



*Thermal ducts*

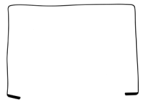

*Display gasket*



*Display films*



*Plastic sheet*



*Plastic bracket*

**Primary Target Material**



**Rare Earth Magnets**

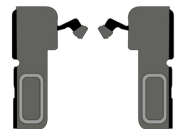

*Speakers*

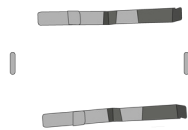

*Magnets*

**Primary Target Material**



**Potential Additional Materials**

