



MacBook Air (M1, 2020)

Apple Recycler Guide

July 2023

Contents

3	About This Guide
4	Identification
5	Directive 2012/19/EU Annex VII Components
6	Safety Considerations
9	Recommended Tools
10	Disassembly Instructions
27	Material Categorization of Output Fractions

About This Guide

Apple Recycler Guides provide guidance for electronics recyclers on how to disassemble products to maximize recovery of resources. The guides provide step-by-step disassembly instructions and information on the material composition to help recyclers direct fractions to the appropriate material recycler.

To conserve important resources, we work to reduce the materials we use and aim to one day source only recycled or renewable materials in our products. A key path to reaching that goal is resource recovery from end-of-life electronics.

Disassembly procedures are intended to be performed only by trained electronics recycling professionals. The recycler is responsible for independently evaluating and ensuring compliance with all applicable environmental, health, and safety laws related to the work. These include but are not limited to laws relating to the management, handling, shipping, and disposal of the outputs of this work as waste and laws in place to ensure the health and safety of all employees who support this work.

For questions or feedback about this guide, email contactesci@apple.com.

Identification

You can find the model number on the underside of the MacBook Air.

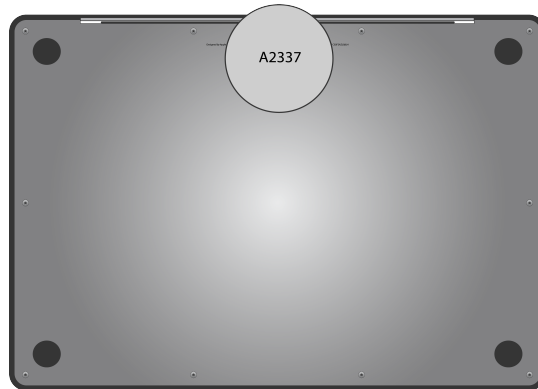

Model number:
A2337

Directive 2012/19/EU Annex VII Components

Directive 2012/19/EU Annex VII requirements apply to the following substances and components.

Substance/Component	Apple Part Name	Removal Instructions
Printed circuit board if the surface is greater than 10 square centimeters	Main logic board, data board assembly, keyboard, trackpad, light-emitting diode (LED) logic board	Follow steps 1–22
External electric cables	Charge cable	Follow step 1
Battery	Lithium-ion polymer batteries	Follow steps 1–3
Cover glass and liquid crystal display (LCD) cell if the surface is greater than 100 square centimeters	Display	Follow steps 1–18
No further substances or components as listed in Annex VII		

Safety Considerations

The recycler is responsible for independently evaluating all activities undertaken by its employees to perform or support the work and ensuring compliance with all applicable health and safety laws related to the work. These include but are not limited to laws relating to the health and safety of all employees who perform or support this work. The recycler is also responsible for evaluating the workspace and ensuring that the area in which the work is to be undertaken is designed using ergonomic best practices and meets all ergonomic requirements to ensure the protection of its employees.

Personal Protective Equipment

Personal protective equipment should be worn during the entire recycling process.



Wear hand protection



Wear a mask



Wear eye protection



Wear foot protection



Wear protective clothing

Battery Safety

This product uses a lithium-ion polymer battery. Before beginning any disassembly work, ensure that a safe working procedure for handling lithium-ion batteries has been established, which could include discharging the batteries so that they can be more safely managed. The following considerations may also be included:

- Remove anything from your person that could conduct energy, such as jewelry and watches, to avoid electric shock to yourself or the logic board.
- To avoid the potential for thermal runaway and the release of potentially noxious fumes, don't puncture, strike, or crush lithium-ion polymer batteries or devices powered by them.
- Don't throw, drop, or bend the battery.
- Don't expose the battery to excessive heat or sunlight.
- Don't use tools that are sharp or conduct electricity.
- Keep your workspace clear of foreign objects and sharp materials.
- Dispose of batteries according to local environmental laws and guidelines.

Workspace safety guidelines

- Use heat-resistant gloves and safety glasses.
- Keep a sand dispenser within arm's reach (2 feet or 0.6 m) on one side of the workstation, not above the workstation. The dispenser should be a wide-mouthed, quick-pour metal container with a flip-top lid or tray that contains 8–10 cups (1.9–2.4 L) of clean, dry, untreated sand.
- Keep the battery at least 2 feet (0.6 m) from paper and other combustible materials.
- Work in an area with adequate ventilation.

Handling a thermal runaway

If you notice any of the following signs, a thermal runaway is likely underway, and you should act immediately:

- The lithium-ion polymer battery or a device containing one begins to smoke or emit sparks or soot.
- The battery pouch suddenly and quickly puffs out.
- You hear hissing or popping sounds.

Don't use water or an ABC/CO₂ fire extinguisher on a thermal runaway battery or a device containing one. Water and ABC/CO₂ fire extinguishers will not stop the reaction.

Do smother the battery or device immediately with plenty of clean, dry sand, dumped all at once. Timing is critical; the faster you pour all the sand, the faster the thermal runaway will stop.

Do leave the room for 30 minutes if the thermal runaway causes any irritation.

Do wait 30 minutes before touching the battery. Wear heat-resistant gloves and safety glasses to remove the battery from the sand, or use a touchless thermometer to measure the battery temperature. Only touch the battery when the event has finished.

Do dispose of the damaged battery or device (including any debris removed from the sand) according to local environmental laws and guidelines.

LED Safety

Broken LEDs must be handled properly to ensure the safety of your employees and mitigate any hazards. Package broken LEDs in an appropriate container to properly manage the hazards associated with the materials and store only with compatible materials. All waste must be properly classified, packaged, and labeled in accordance with all relevant laws and regulations.

Hazard Warnings



Rechargeable battery hazard



Sharp edges—cut hazard



Broken glass hazard



Chemical exposure hazard



Chemical inhalation hazard

Recommended Tools

Nail-pulling screwdriver

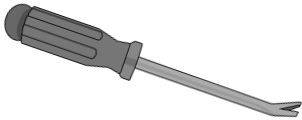

Plastic pry bar

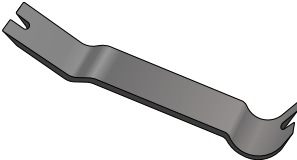

Screwdriver-handle pry bar



Torx T3 screwdriver

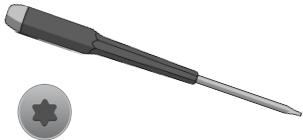

Torx T5 screwdriver

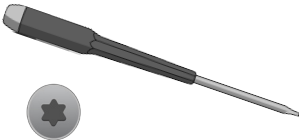

Wire cutters

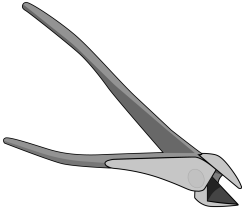

Disassembly Instructions

1. Remove the power adapter and the charge cable.

- » *Ensure that the MacBook Air is turned off.*
- » *Unplug the power adapter. Disconnect both ends of the charge cable.*

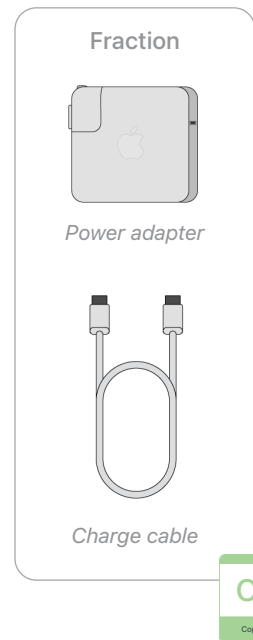

2. Carefully pry off the bottom case near the fasteners to avoid damage to the batteries.

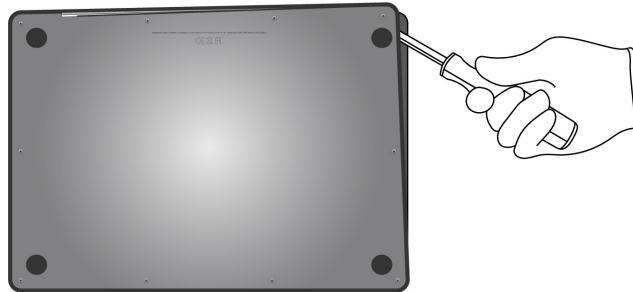

Tools Used

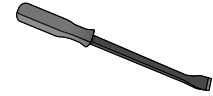

Fraction



Bottom case

AI

Aluminum

3. From the top case, carefully remove the three lithium-ion polymer batteries.



Rechargeable battery hazard

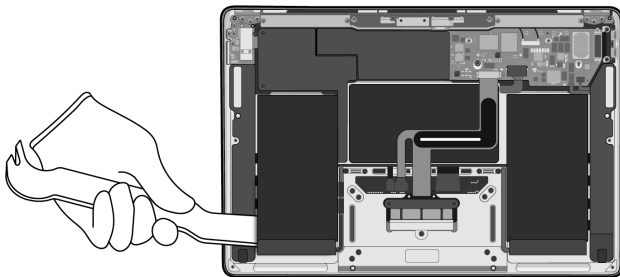

Tools Used

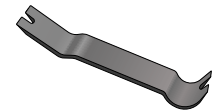

Fraction



Lithium-ion polymer batteries

BT

Battery

4. Pull off the ribbon cable and battery cable.

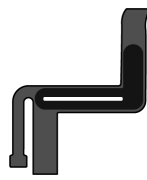
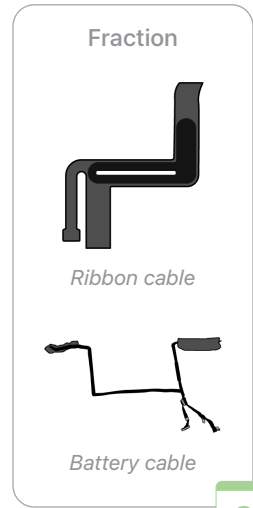
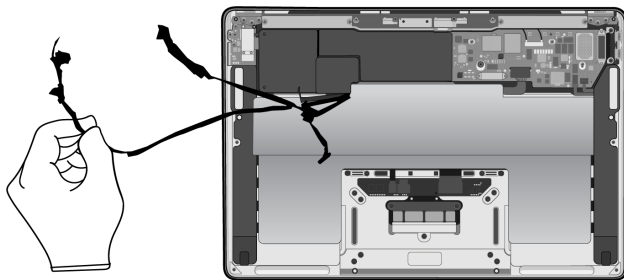
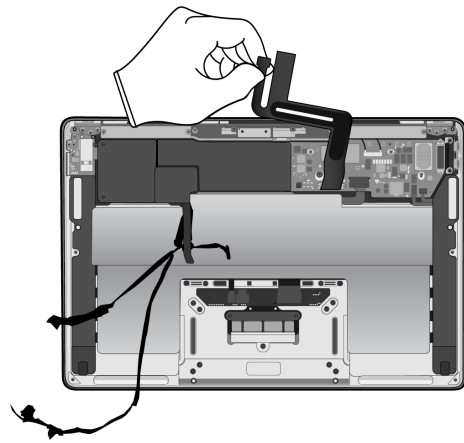

Ribbon cable



Battery cable



5. Pry off both speakers.

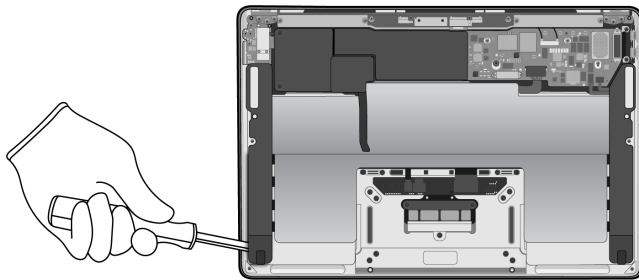

Tools Used



Fraction

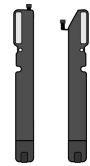

Speakers

REE

Rare Earth Elements

6. Remove the power supply logic board.

- » *Pull the power supply sheet off the power supply logic board.*

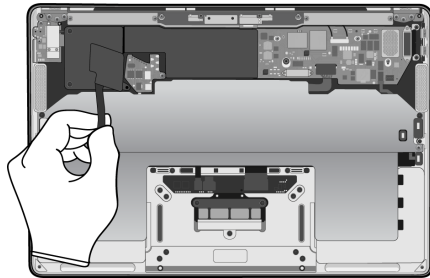

- » *Pry off the power supply logic board.*

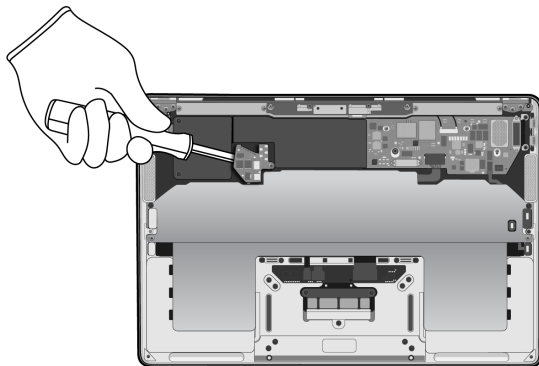

Tools Used

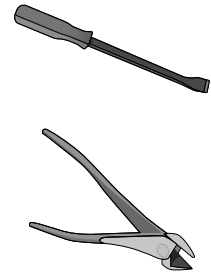

Fraction



Power supply sheet

PL

Plastics

- » *Unplug the power supply cable from the main logic board.*

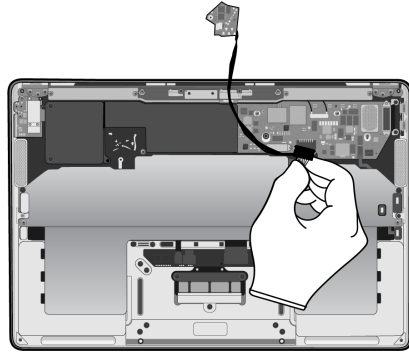

- » *Cut the power supply cable off the power supply logic board.*

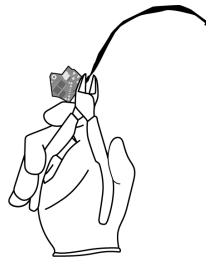

Fraction



Power supply cable

Cu
Copper

A diagram showing a black power supply cable. To its right is a green box containing the chemical symbol 'Cu' and the word 'Copper' below it.

Fraction



Power supply logic board

PMs
Precious Metals

A diagram showing a grey power supply logic board with various components. To its right is a green box containing the letters 'PMs' and the words 'Precious Metals' below it.

7. Pry off the battery shield.

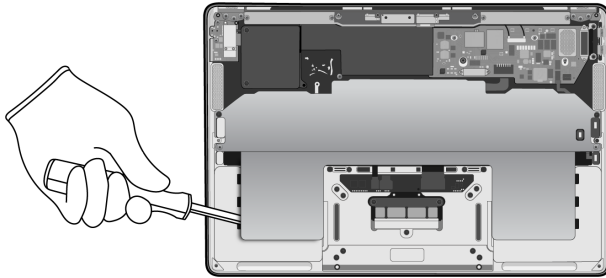

Tools Used

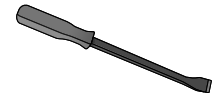

Fraction

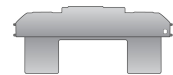

Battery shield

Fe

Ferrous

8. Remove the trackpad by unscrewing the nine Torx T5 fasteners.

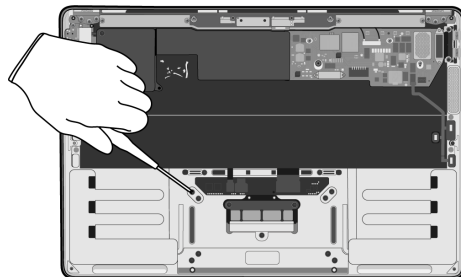

Tools Used

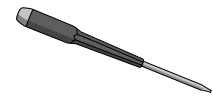

Fraction



Fasteners (x9)

Fe

Ferrous

Fraction

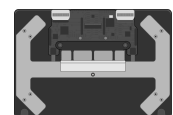

Trackpad

PMs

Precious Metals

- 9.** Pry off the main logic board. Then set the top case aside.

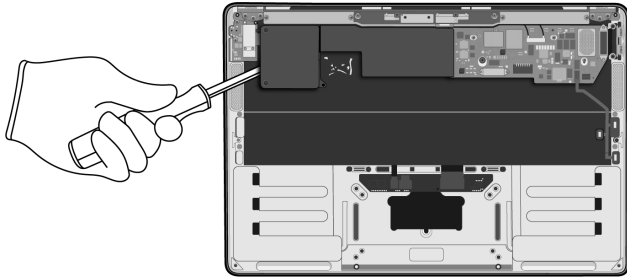

Tools Used



- 10.** Separate the heat sink from the main logic board by prying off the retaining brackets. Then set the heat sink aside.

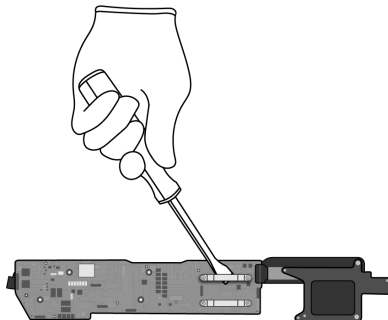

Tools Used

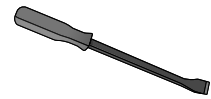

Fraction

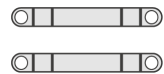

Retaining brackets

Fe

Ferrous

11. Pull the ribbon cable off the main logic board.

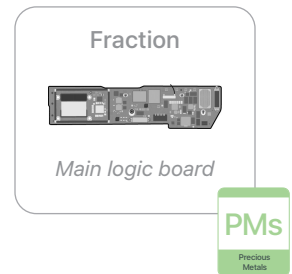
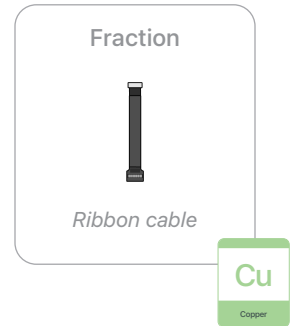
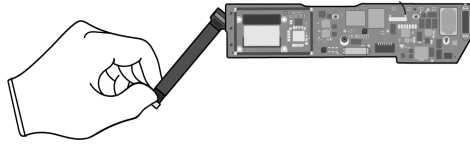

12. Remove the heat sink bracket from the heat sink by unscrewing the two Torx T5 fasteners.

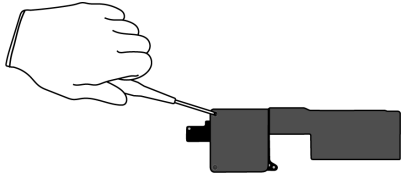

Tools Used

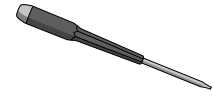

Fraction



Fasteners (x2)

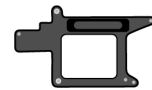

Heat sink bracket

Fe

Ferrous

Fraction



Heat sink

Al

Aluminum

13. Pry off the keyboard logic board.

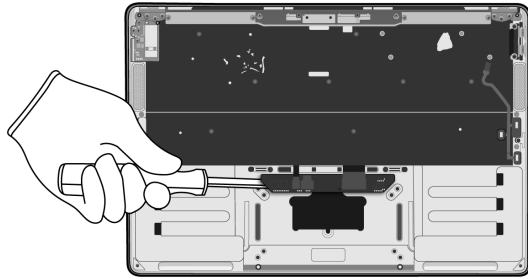

Tools Used



Fraction



Keyboard
logic board

PMs
Precious
Metals

14. Separate the display and top case by bending them back and forth until the hinges break.



Sharp edges—cut hazard

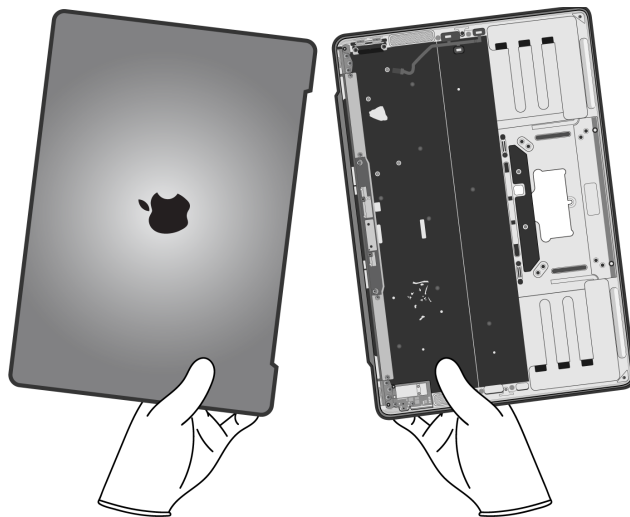

15. Separate the keyboard and trackpad enclosure by breaking the top case in half.

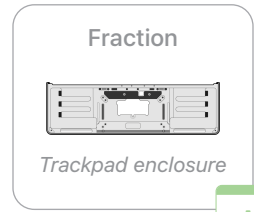
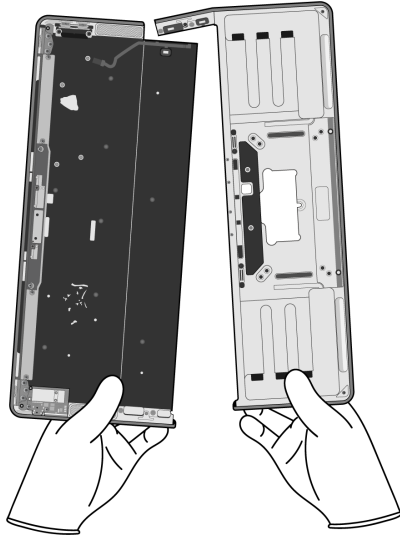
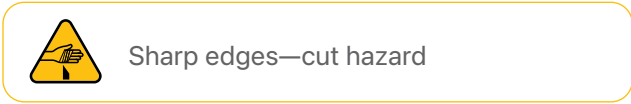

16. Remove the keyboard sheet from the keyboard by hand.

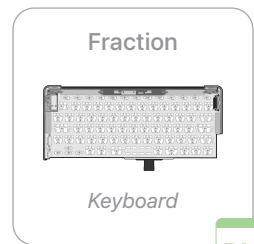
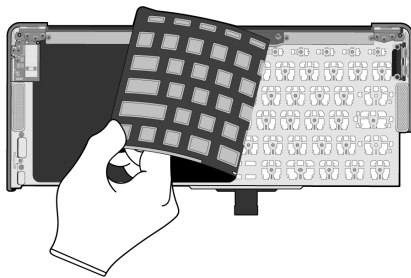

17. Pull off the display gasket.

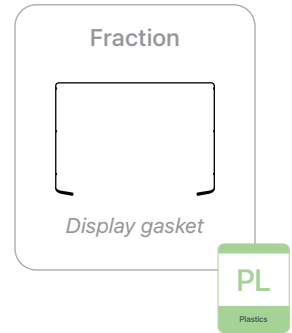
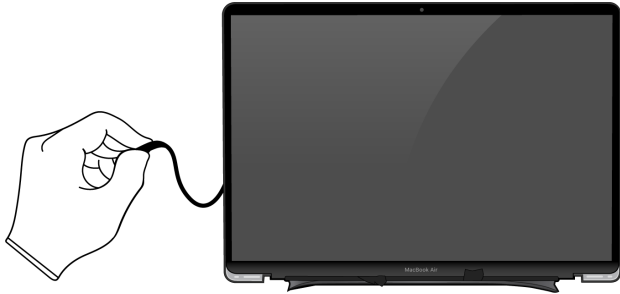

18. Pry away the LCD cell and display films from the display housing.

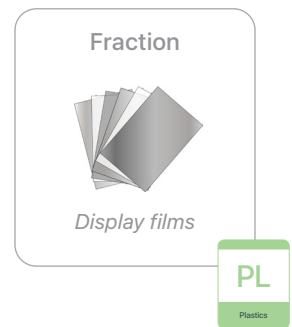
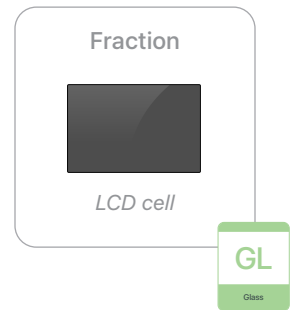
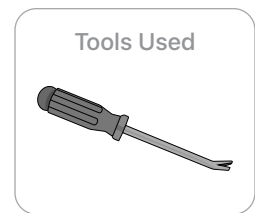
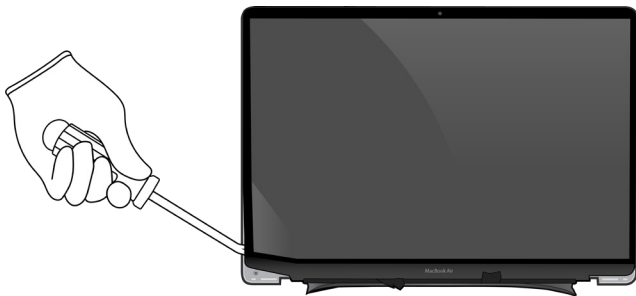
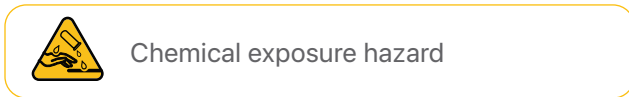
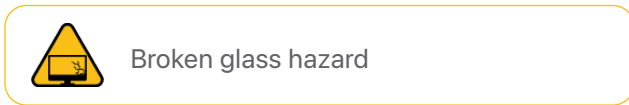

19. Remove the camera with logic board by unscrewing the two Torx T3 fasteners.

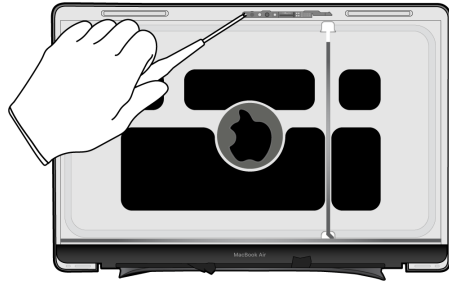

Tools Used

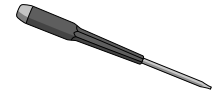

Fraction



Fasteners (x2)

Fe

Ferrous

Fraction



Camera with
logic board

PMs

Precious
Metals

20. Remove the camera/LED ribbon cable that goes between the camera and the LED logic board.

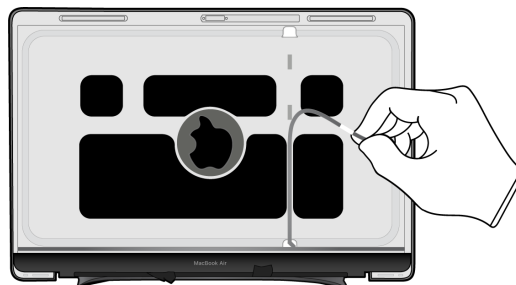

Fraction



Camera/LED
ribbon cable

Cu

Copper

21. Pry off the data board assembly.

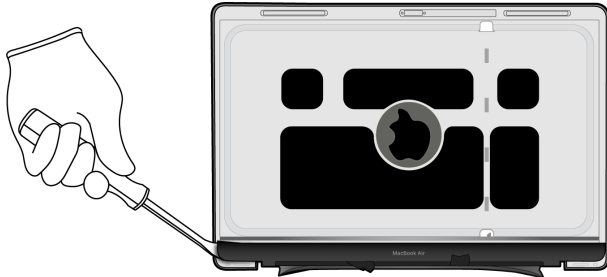

Tools Used

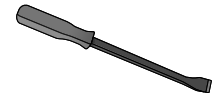

Fraction



Data board assembly

PMs
Precious Metals

22. Pry off the LED logic board.



Chemical inhalation hazard

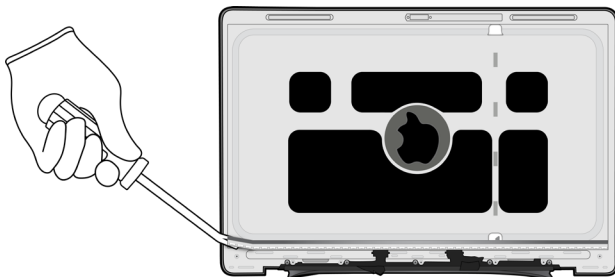

Tools Used

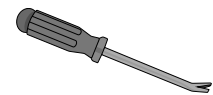

Fraction



LED logic board

PMs
Precious Metals

23. Pry off the plastic bracket. Then pull off the ribbon cables by hand.

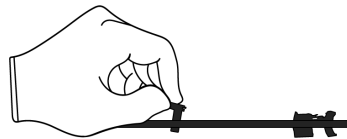
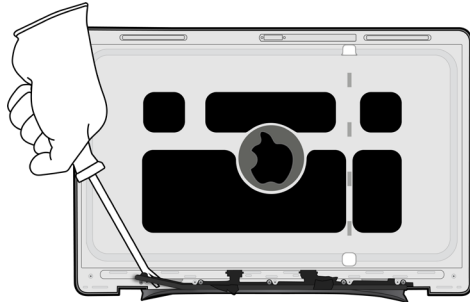

Tools Used

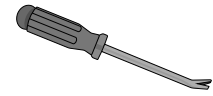

Fraction



Ribbon cables

Cu

Copper

Fraction



Plastic bracket

PL

Plastics

24. Remove the magnets.

» Bend the display housing to pop up the four magnets.

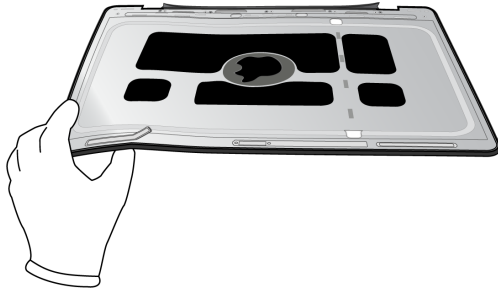

Tools Used

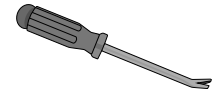

» Pry off the magnets.

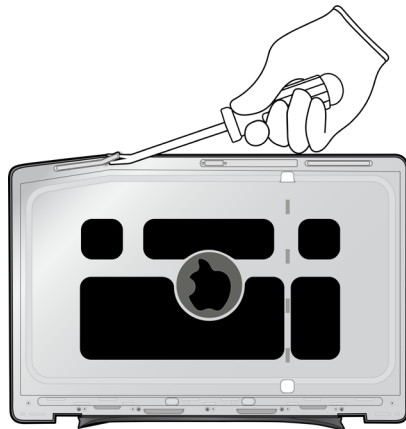

Fraction

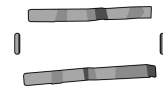

Magnets

REE

Rare Earth
Elements

Fraction











Display housing

Al

Aluminum

Material Categorization of Output Fractions

All outputs from this process must be managed, handled, and disposed of in accordance with applicable waste laws and regulations, including but not limited to the Waste Framework Directive and its national enactments in Europe.

Fraction	Downstream Processing
<p data-bbox="435 594 565 621">Aluminum</p>  <p data-bbox="440 800 560 825"><i>Bottom case</i></p>  <p data-bbox="453 947 545 972"><i>Heat sink</i></p>  <p data-bbox="407 1094 592 1119"><i>Trackpad enclosure</i></p>  <p data-bbox="423 1293 576 1318"><i>Display housing</i></p>	<p data-bbox="964 594 1273 621">Primary Target Material</p>  <p data-bbox="932 821 1305 848">Potential Additional Material</p> 
<p data-bbox="440 1413 565 1440">Batteries</p>  <p data-bbox="358 1581 641 1606"><i>Lithium-ion polymer batteries</i></p>	<p data-bbox="964 1413 1273 1440">Primary Target Material</p> 

Fraction

Downstream Processing

Ferrous

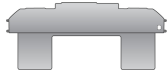

Battery shield



Fasteners (x13)



Retaining brackets

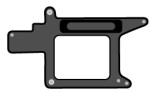

Heat sink bracket

Primary Target Material



Glass



LCD cell

Primary Target Material



Potential Additional Materials



Fraction

Downstream Processing

Logic Boards



Power supply logic board

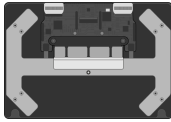

Trackpad



Main logic board



Keyboard logic board



Keyboard



Camera with logic board



Data board assembly



LED logic board

Primary Target Material



Potential Additional Materials



Fraction

Downstream Processing

Mixed Electronics



Power adapter

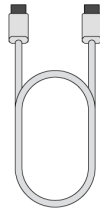

Charge cable

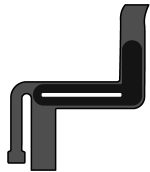

Ribbon cable



Battery cable



Power supply cable



Ribbon cable

Primary Target Material



Potential Additional Materials



Fraction

Downstream Processing

Mixed Electronics (cont.)



Keyboard sheet



Camera/LED ribbon cable



Ribbon cables

Mixed Plastics



Power supply sheet

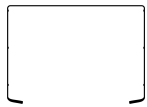

Display gasket



Display films



Plastic bracket

Primary Target Material



Fraction

Downstream Processing

Rare Earth Magnets



Speakers

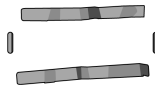

Magnets

Primary Target Material



Potential Additional Materials

