



MacBook Pro (13-inch, 2016, Four Thunderbolt 3 ports)

MacBook Pro (13-inch, 2017, Four Thunderbolt 3 ports)

MacBook Pro (13-inch, 2018, Four Thunderbolt 3 ports)

MacBook Pro (13-inch, 2019, Four Thunderbolt 3 ports)

MacBook Pro (13-inch, 2020, Four Thunderbolt 3 ports)

Apple Recycler Guide

July 2023

Contents

3	About This Guide
4	Identification
5	Directive 2012/19/EU Annex VII Components
6	Safety Considerations
9	Recommended Tools
10	Disassembly Instructions
24	Material Categorization of Output Fractions

About This Guide

Apple Recycler Guides provide guidance for electronics recyclers on how to disassemble products to maximize recovery of resources. The guides provide step-by-step disassembly instructions and information on the material composition to help recyclers direct fractions to the appropriate material recycler.

To conserve important resources, we work to reduce the materials we use and aim to one day source only recycled or renewable materials in our products. A key path to reaching that goal is resource recovery from end-of-life electronics.

Disassembly procedures are intended to be performed only by trained electronics recycling professionals. The recycler is responsible for independently evaluating and ensuring compliance with all applicable environmental, health, and safety laws related to the work. These include but are not limited to laws relating to the management, handling, shipping, and disposal of the outputs of this work as waste and laws in place to ensure the health and safety of all employees who support this work.

For questions or feedback about this guide, email contactesci@apple.com.

Note: This guide may show images from other similar models, but the procedures are the same.

Identification

You can find the model number printed on the underside of the MacBook Pro, near the regulatory markings.



Model numbers:
A1706, A1989, A2251

Directive 2012/19/EU Annex VII Components

Directive 2012/19/EU Annex VII requirements apply to the following substances and components.

Substance/Component	Apple Part Name	Removal Instructions
Printed circuit board if the surface is greater than 10 square centimeters	Main logic board, trackpad, keyboard, data board assembly, camera with logic board, light-emitting diode (LED) logic board	Follow steps 1–18
External electric cables	Power adapter, charge cable	Follow step 1
Battery	Lithium-ion polymer batteries	Follow steps 1–3
Cover glass and liquid crystal display (LCD) cell if the surface is greater than 100 square centimeters	LCD cell	Follow steps 1–15
No further substances or components as listed in Annex VII		

Safety Considerations

The recycler is responsible for independently evaluating all activities undertaken by its employees to perform or support the work and ensuring compliance with all applicable health and safety laws related to the work. These include but are not limited to laws relating to the health and safety of all employees who perform or support this work. The recycler is also responsible for evaluating the workspace and ensuring that the area in which the work is to be undertaken is designed using ergonomic best practices and meets all ergonomic requirements to ensure the protection of its employees.

Personal Protective Equipment

Personal protective equipment should be worn during the entire recycling process.



Wear hand protection



Wear a mask



Wear eye protection



Wear foot protection



Wear protective clothing

Battery Safety

This product uses a lithium-ion polymer battery. Before beginning any disassembly work, ensure that a safe working procedure for handling lithium-ion batteries has been established, which could include discharging the batteries so that they can be more safely managed. The following considerations may also be included:

- Remove anything from your person that could conduct energy, such as jewelry and watches, to avoid electric shock to yourself or the logic board.
- To avoid thermal runaway and the release of noxious fumes, don't puncture, strike, or crush lithium-ion polymer batteries or devices powered by them.
- Don't throw, drop, or bend the battery.
- Don't expose the battery to excessive heat or sunlight.
- Don't use tools that are sharp or conduct electricity.
- Keep your workspace clear of foreign objects and sharp materials.
- Dispose of batteries according to local environmental laws and guidelines.

Workspace safety guidelines

- Use heat-resistant gloves and safety glasses.
- Keep a sand dispenser within arm's reach (2 feet or 0.6 m) on one side of the workstation, not above the workstation. The dispenser should be a wide-mouthed, quick-pour metal container with a flip-top lid or tray that contains 8–10 cups (1.9–2.4 L) of clean, dry, untreated sand.
- Keep the battery at least 2 feet (0.6 m) from paper and other combustible materials.
- Work in an area with adequate ventilation.

Handling a thermal runaway

If you notice any of the following signs, a thermal runaway is likely underway, and you should act immediately:

- The lithium-ion polymer battery or a device containing one begins to smoke or emit sparks or soot.
- The battery pouch suddenly and quickly puffs out.
- You hear hissing or popping sounds.

Don't use water or an ABC/CO₂ fire extinguisher on a thermal runaway battery or a device containing one. Water and ABC/CO₂ fire extinguishers will not stop the reaction.

Do smother the battery or device immediately with plenty of clean, dry sand, dumped all at once. Timing is critical; the faster you pour all the sand, the faster the thermal runaway will stop.

Do leave the room for 30 minutes if the thermal runaway causes any irritation.

Do wait 30 minutes before touching the battery. Wear heat-resistant gloves and safety glasses to remove the battery from the sand, or use a touchless thermometer to measure the battery temperature. Only touch the battery when the event has finished.

Do dispose of the damaged battery or device (including any debris removed from the sand) according to local environmental laws and guidelines.

LED Safety

Broken light-emitting diodes (LEDs) must be handled properly to ensure the safety of your employees and mitigate any hazards. Package broken LEDs in an appropriate container to properly manage the hazards associated with the materials and store only with compatible materials. All waste must be properly classified, packaged, and labeled in accordance with all relevant laws and regulations.

Hazard Warnings



Sharp edges—cut hazard



Chemical inhalation hazard



Chemical exposure hazard



Rechargeable battery hazard



Broken glass hazard

Recommended Tools

Miniature pry bar

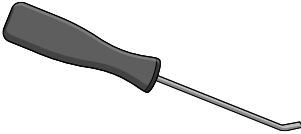

Nail-pulling screwdriver

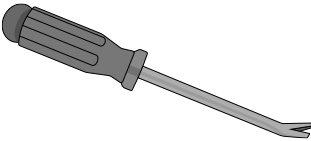

Plastic flat-surface scraper

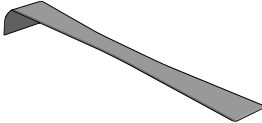

Torx T2 screwdriver

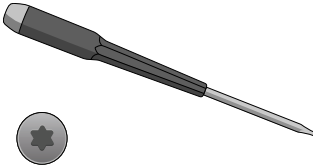

Torx T5 screwdriver

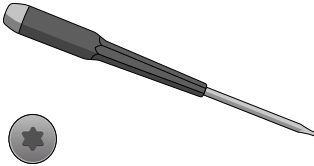

Disassembly Instructions

1. Remove the power adapter and the charge cable.

» *Ensure that the MacBook Pro is turned off.*



» *Unplug and remove the power adapter and the charge cable.*

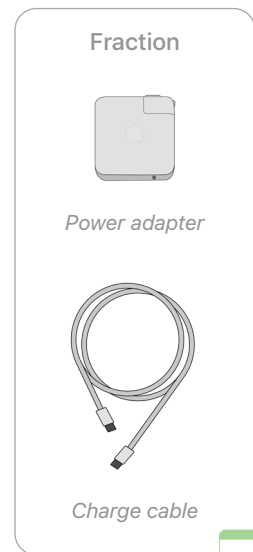
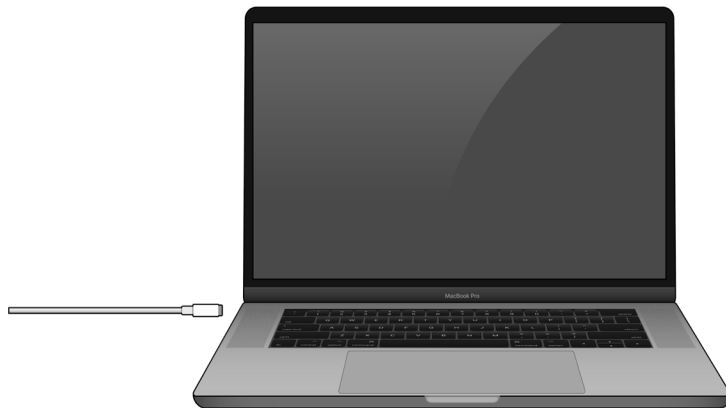

2. Pry off the bottom case.

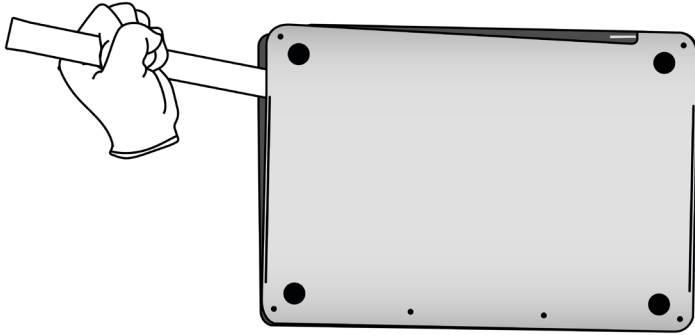

Tools Used

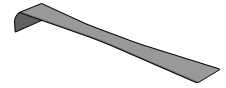

Fraction



Bottom case

Al

Aluminum

3. From the top case, carefully remove the five lithium-ion polymer batteries.



Rechargeable battery hazard

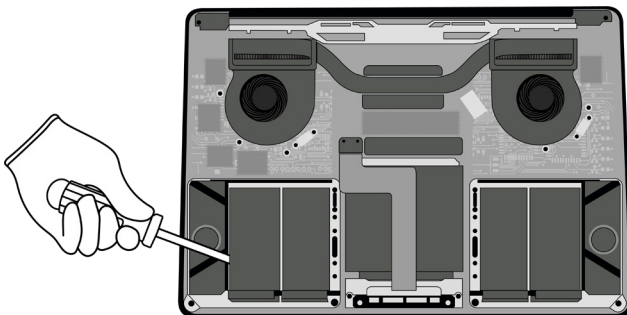

Tools Used

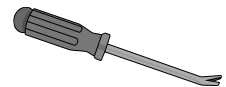

Fraction



Lithium-ion polymer batteries

BT

Battery

4. Pry off both speakers.

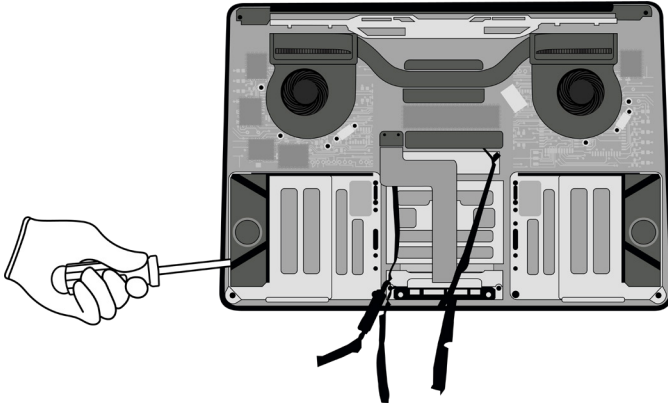

Tools Used

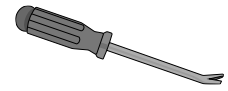

Fraction



Speakers

REE
Rare Earth
Elements

5. Pull off the ribbon cables.

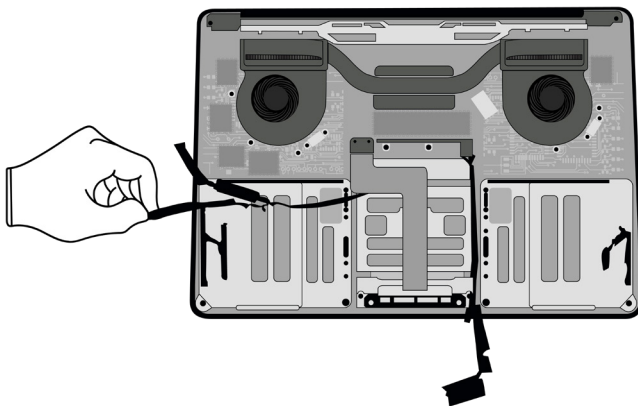

Fraction



Ribbon cables

Cu
Copper

6. Pry off the battery brackets.

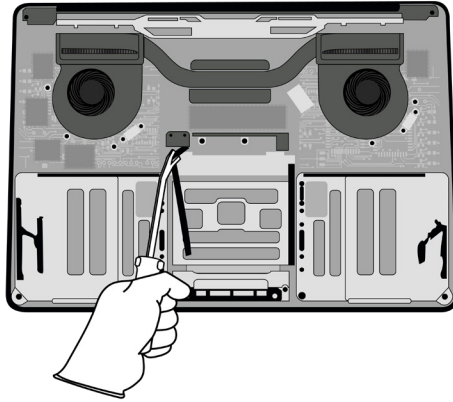

Tools Used

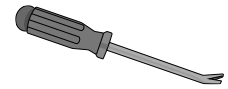

Fraction



Battery brackets

PL

Plastics

7. Pull off the thermal ducts.

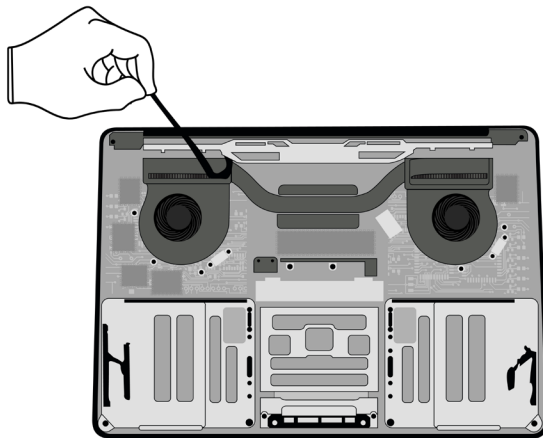

Fraction



Thermal ducts

PL

Plastics

8. Pry off the main logic board.

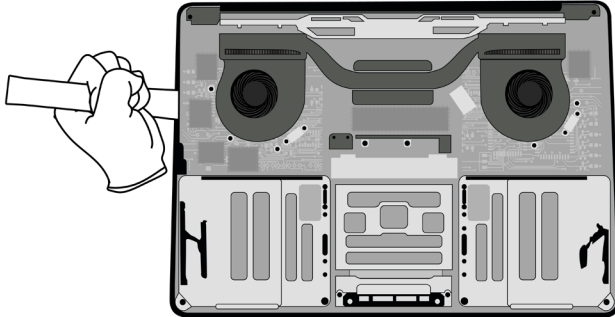

Tools Used

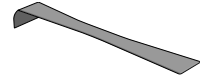

Fraction



Main logic board

PMs
Precious Metals

9. Pry off both fans.

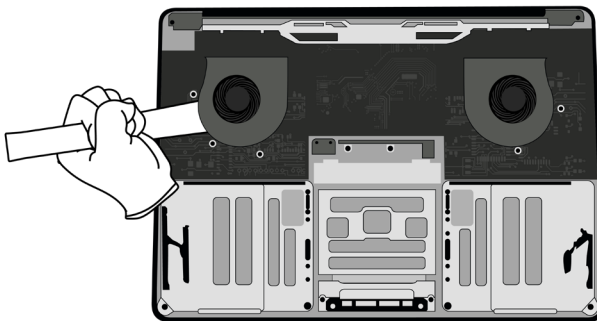

Tools Used



Fraction

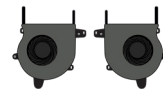

Fans

Cu
Copper

10. Remove the trackpad by unscrewing the 10 Torx T5 fasteners.

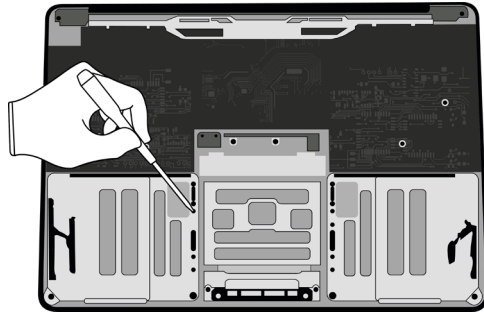

Tools Used

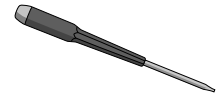

Fraction



Trackpad

PMs

Precious Metals

Fraction



Fasteners (x10)

Fe

Ferrous

11. Separate the display and top case by bending them back and forth at the hinge until they break in two. Set the display aside.

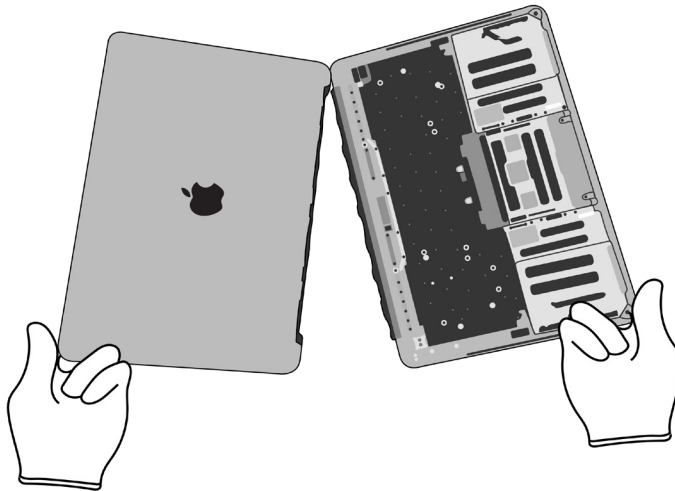
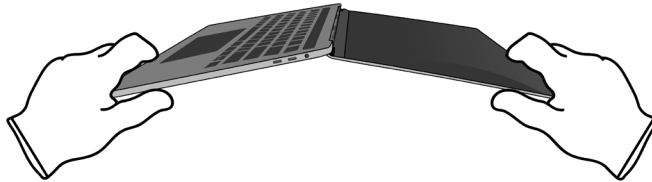

- 12.** Separate the keyboard from the trackpad enclosure by snapping the top case in half.

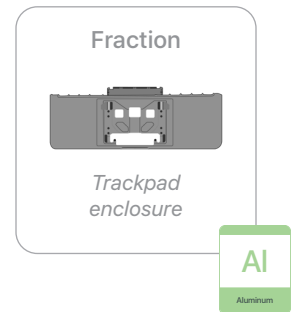
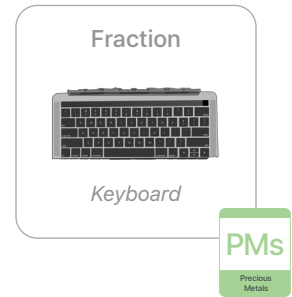
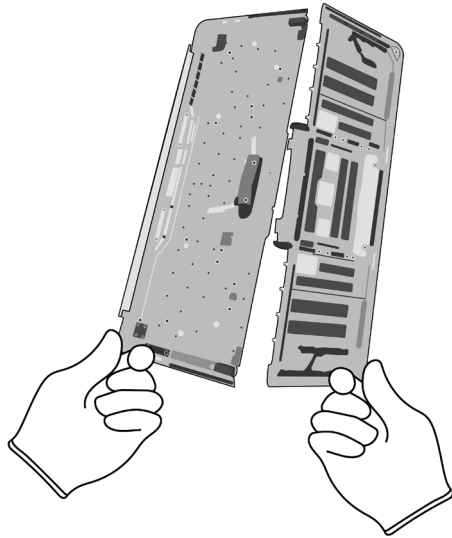

- 13.** On the display, pull off the display gasket.

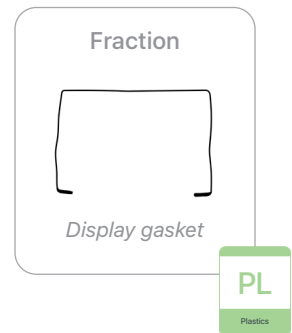
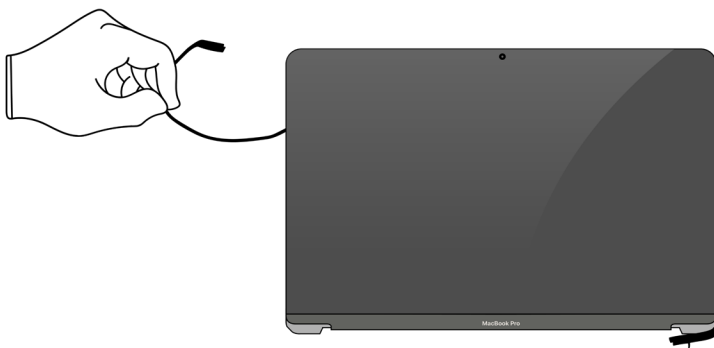

14. Pry the display films away from the LCD cell and data board assembly.



Broken glass hazard



Chemical exposure hazard

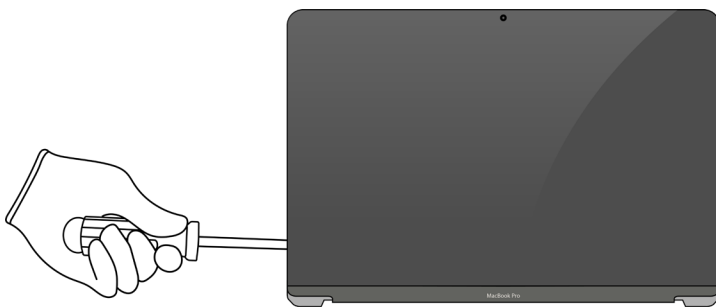

Tools Used

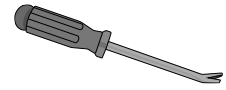

Fraction



Display films

PL

Plastics

15. Pull the data board assembly off the LCD cell.

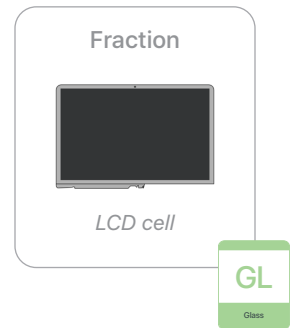
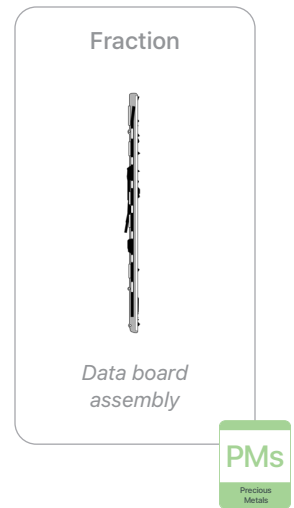
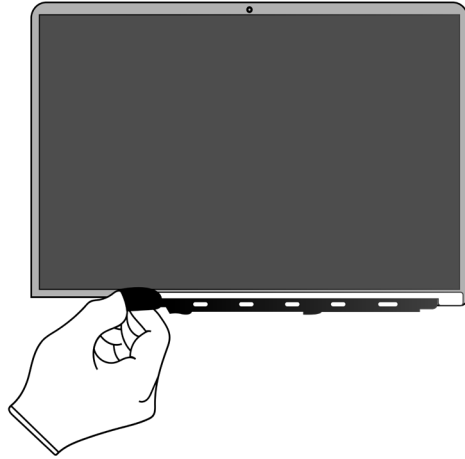

16. Remove the camera with logic board.

- » *Unscrew the three Torx T2 screws holding the camera with logic board to the display.*

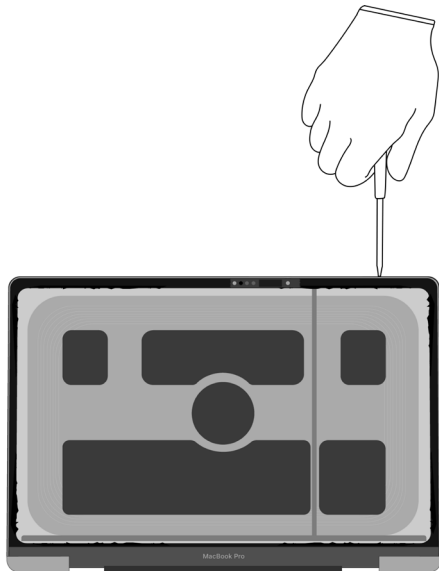
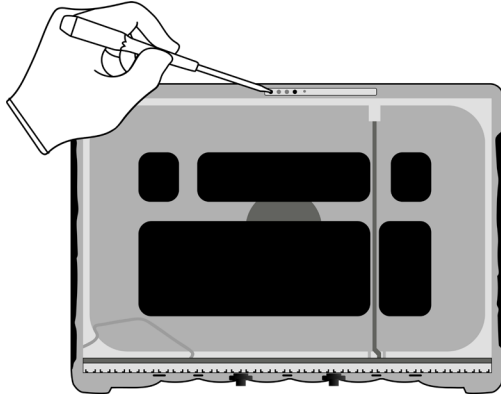

Tools Used

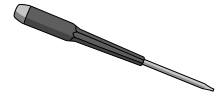

Fraction



Fasteners

Fe

Ferrous

Fraction



Camera with logic board

PMs

Precious Metals

» *Disconnect the wire from the camera by hand.*

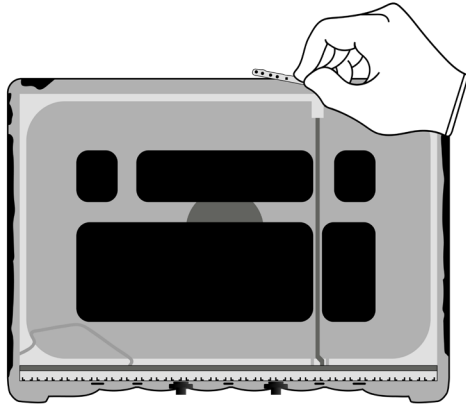

17. Remove the wire leading to the LED logic board.

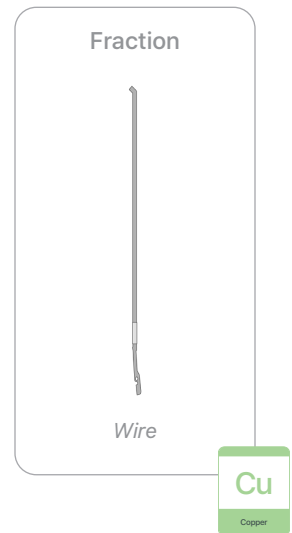
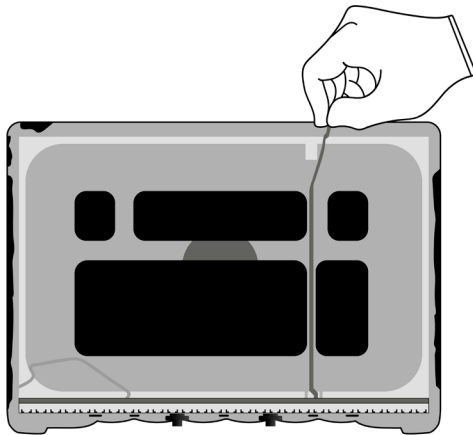

18. Pry off the LED logic board.



Chemical inhalation hazard

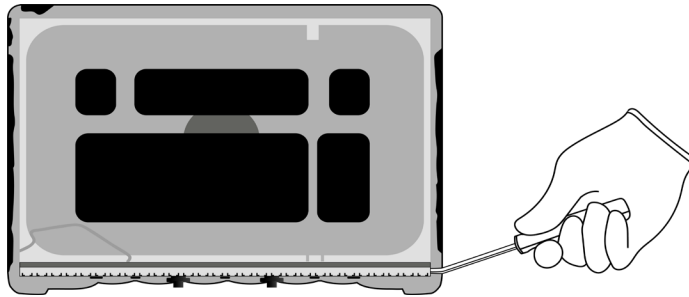

Tools Used

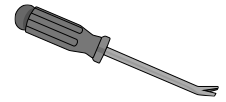

Fraction



LED logic board



19. Remove the magnets.

» *Bend the display housing to pop up the four magnets.*

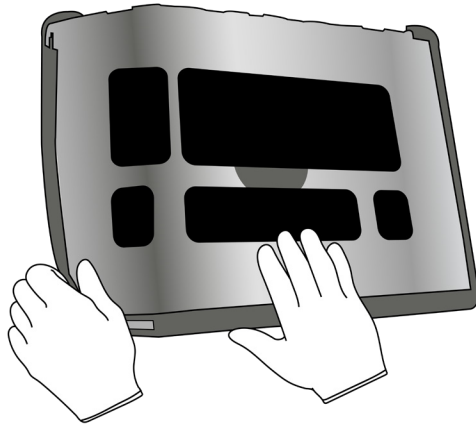

» *Pry off the magnets.*

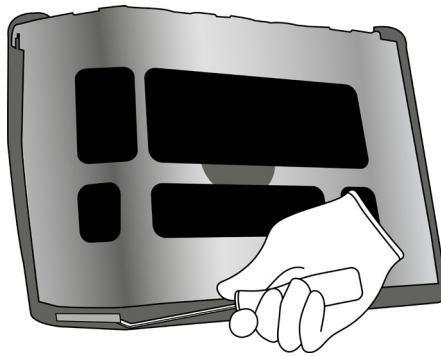

Tools Used



Fraction

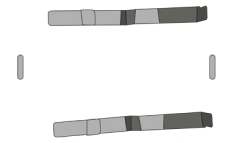

Magnets

REE

Rare Earth
Elements

Fraction









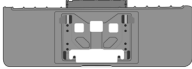

Display
housing

Al

Aluminum

Material Categorization of Output Fractions

All outputs from this process must be managed, handled, and disposed of in accordance with applicable waste laws and regulations, including but not limited to the Waste Framework Directive and its national enactments in Europe.

Fraction	Downstream Processing
<p data-bbox="435 604 570 636">Aluminum</p> <div data-bbox="435 678 570 772">  <p data-bbox="440 779 565 804"><i>Bottom case</i></p> </div> <div data-bbox="407 852 597 919">  <p data-bbox="407 936 597 961"><i>Trackpad enclosure</i></p> </div> <div data-bbox="431 1010 573 1115">  <p data-bbox="427 1129 578 1155"><i>Display housing</i></p> </div>	<p data-bbox="964 604 1276 636">Primary Target Material</p> <div data-bbox="1084 678 1154 772">  </div> <p data-bbox="927 831 1313 863">Potential Additional Materials</p> <div data-bbox="1084 905 1154 999">  </div>
<p data-bbox="440 1249 565 1281">Batteries</p> <div data-bbox="399 1323 605 1381">  <p data-bbox="358 1398 646 1423"><i>Lithium-ion polymer batteries</i></p> </div>	<p data-bbox="964 1249 1276 1281">Primary Target Material</p> <div data-bbox="1084 1323 1154 1417">  </div>
<p data-bbox="448 1522 557 1554">Ferrous</p> <div data-bbox="467 1591 545 1675">  <p data-bbox="427 1690 578 1715"><i>Fasteners (x13)</i></p> </div>	<p data-bbox="964 1522 1276 1554">Primary Target Material</p> <div data-bbox="1084 1591 1154 1686">  </div>

Fraction

Downstream Processing

Glass



LCD cell

Primary Target Material



Potential Additional Materials



Logic Boards

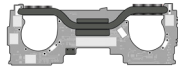

Main logic board

Primary Target Material



Potential Additional Materials



Trackpad



Keyboard



Data board assembly



Camera with logic board



LED logic board

Fraction

Downstream Processing

Mixed Electronics



Power adapter



Charge cable



Ribbon cables



Fans



Wire

Primary Target Material



Potential Additional Materials



Fraction

Downstream Processing

Mixed Plastics



Battery brackets



Thermal ducts

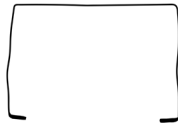

Display gasket



Display films

Primary Target Material



Rare Earth Magnets



Speakers

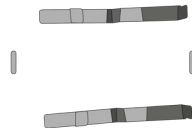

Magnets

Primary Target Material



Potential Additional Materials

