



iPad (6th generation) Wi-Fi

iPad (6th generation) Wi-Fi + Cellular

iPad (7th generation) Wi-Fi

iPad (7th generation) Wi-Fi + Cellular

iPad (8th generation) Wi-Fi

iPad (8th generation) Wi-Fi + Cellular

Apple Recycler Guide

May 2023

Contents

3	About This Guide
4	Identification
5	Directive 2012/19/EU Annex VII Components
6	Safety Considerations
8	Recommended Tools
9	Disassembly Instructions
24	Material Categorization of Output Fractions

About This Guide

Apple Recycler Guides provide guidance for electronics recyclers on how to disassemble products to maximize recovery of resources. The guides provide step-by-step disassembly instructions and information on the material composition to help recyclers direct fractions to the appropriate material recycler.

To conserve important resources, we work to reduce the materials we use and aim to one day source only recycled or renewable materials in our products. A key path to reaching that goal is resource recovery from end-of-life electronics.

Disassembly procedures are intended to be performed only by trained electronics recycling professionals. The recycler is responsible for independently evaluating and ensuring compliance with all applicable environmental, health, and safety laws related to the work. These include but are not limited to laws relating to the management, handling, shipping, and disposal of the outputs of this work as waste and laws in place to ensure the health and safety of all employees who support this work.

For questions or feedback about this guide, email contactesci@apple.com.

Note: This guide may show images from other similar models, but the procedures are the same.

Identification

You can find the model number on the back of the iPad.

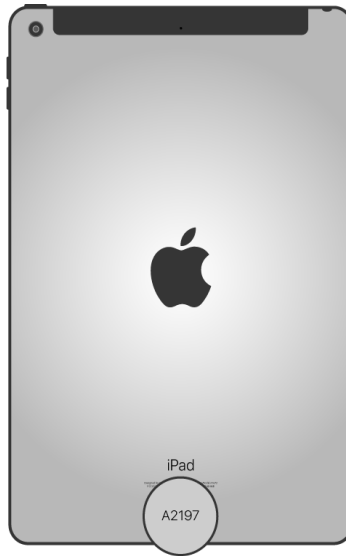

Model numbers:
(Wi-Fi) A1893, A2197, A2270
(Wi-Fi + Cellular) A1954, A2198, A2199,
AA2200, A2428, A2429, A2430

Directive 2012/19/EU Annex VII Components

Directive 2012/19/EU Annex VII requirements apply to the following substances and components.

Substance/Component	Apple Part Name	Removal Instructions
Printed circuit board if the surface is greater than 10 square centimeters	Display logic board, main logic board	Follow steps 1–10
External electric cables	Power adapter, charge cable	Follow step 1
Battery	Lithium-ion polymer batteries	Follow steps 1–8
Cover glass and liquid crystal display (LCD) cell if the surface is greater than 100 square centimeters	LCD cell	Follow steps 1–7
No further substances or components as listed in Annex VII		

Safety Considerations

The recycler is responsible for independently evaluating all activities undertaken by its employees to perform or support the work and ensuring compliance with all applicable health and safety laws related to the work. These include but are not limited to laws relating to the health and safety of all employees who perform or support this work. The recycler is also responsible for evaluating the workspace and ensuring that the area in which the work is to be undertaken is designed using ergonomic best practices and meets all ergonomic requirements to ensure the protection of its employees.

Personal Protective Equipment

Personal protective equipment should be worn during the entire recycling process.



Wear hand protection



Wear protective clothing



Wear eye protection



Wear foot protection

Battery Safety

This product uses a lithium-ion polymer battery. Before beginning any disassembly work, ensure that a safe working procedure for handling lithium-ion batteries has been established, which could include discharging the batteries so that they can be more safely managed. The following considerations may also be included:

- Remove anything from your person that could conduct energy, such as jewelry and watches, to avoid electric shock to yourself or the logic board.
- To avoid the potential for thermal runaway and the release of potentially noxious fumes, don't puncture, strike, or crush lithium-ion polymer batteries or devices powered by them.
- Don't throw, drop, or bend the battery.
- Don't expose the battery to excessive heat or sunlight.
- Don't use tools that are sharp or conduct electricity.
- Keep your workspace clear of foreign objects and sharp materials.
- Dispose of batteries according to local environmental laws and guidelines.

Workspace safety guidelines

- Use heat-resistant gloves and safety glasses.
- Keep a sand dispenser within arm's reach (2 feet or 0.6 m) on one side of the workstation, not above the workstation. The dispenser should be a wide-mouthed, quick-pour metal container with a flip-top lid or tray that contains 8–10 cups (1.9–2.4 L) of clean, dry, untreated sand.
- Keep the battery at least 2 feet (0.6 m) from paper and other combustible materials.
- Work in an area with adequate ventilation.

Handling a thermal runaway

If you notice any of the following signs, a thermal runaway is likely underway, and you should act immediately:

- The lithium-ion polymer battery or a device containing one begins to smoke or emit sparks or soot.
- The battery pouch suddenly and quickly puffs out.
- You hear hissing or popping sounds.

Don't use water or an ABC/CO₂ fire extinguisher on a thermal runaway battery or a device containing one. Water and ABC/CO₂ fire extinguishers will not stop the reaction.

Do smother the battery or device immediately with plenty of clean, dry sand, dumped all at once. Timing is critical; the faster you pour all the sand, the faster the thermal runaway will stop.

Do leave the room for 30 minutes if the thermal runaway causes any irritation.

Do wait 30 minutes before touching the battery. Wear heat-resistant gloves and safety glasses to remove the battery from the sand, or use a touchless thermometer to measure the battery temperature. Only touch the battery when the event has finished.

Do dispose of the damaged battery or device (including any debris removed from the sand) according to local environmental laws and guidelines.

Hazard Warnings



Broken glass hazard



Rechargeable battery hazard



Chemical exposure hazard

Recommended Tools

Miniature pry bar

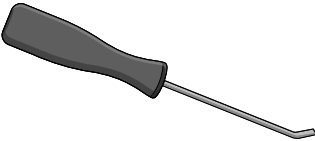

Nail-pulling screwdriver

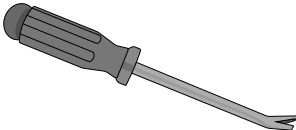

Plastic pry bar

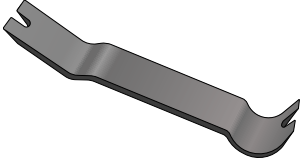

Screwdriver-handle pry bar

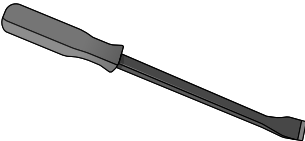

Slip-joint pliers

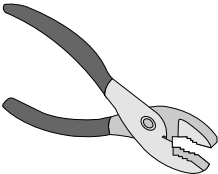

Disassembly Instructions

1. Remove the power adapter and the charge cable.

- » *Ensure that the iPad is turned off.*
- » *Unplug the power adapter. Disconnect both ends of the charge cable.*

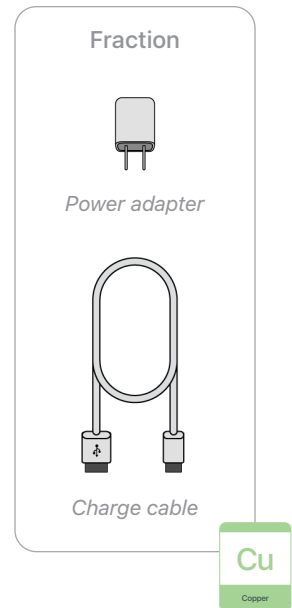
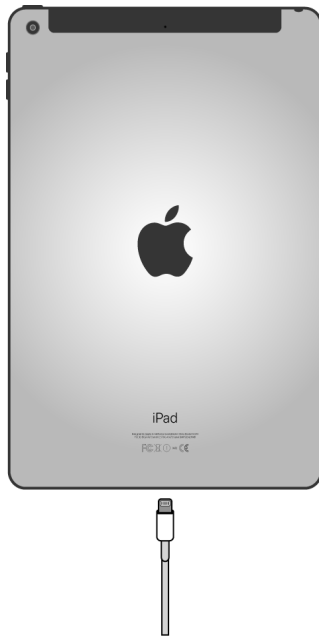

2. Remove the display.



Broken glass hazard



Chemical exposure hazard

- » *Hold the iPad at the edge of a counter with the display facing up.*
- » *Insert the tool tip into the Home button/Touch ID sensor. Push the handle down to pry the display from the enclosure.*

Tools Used

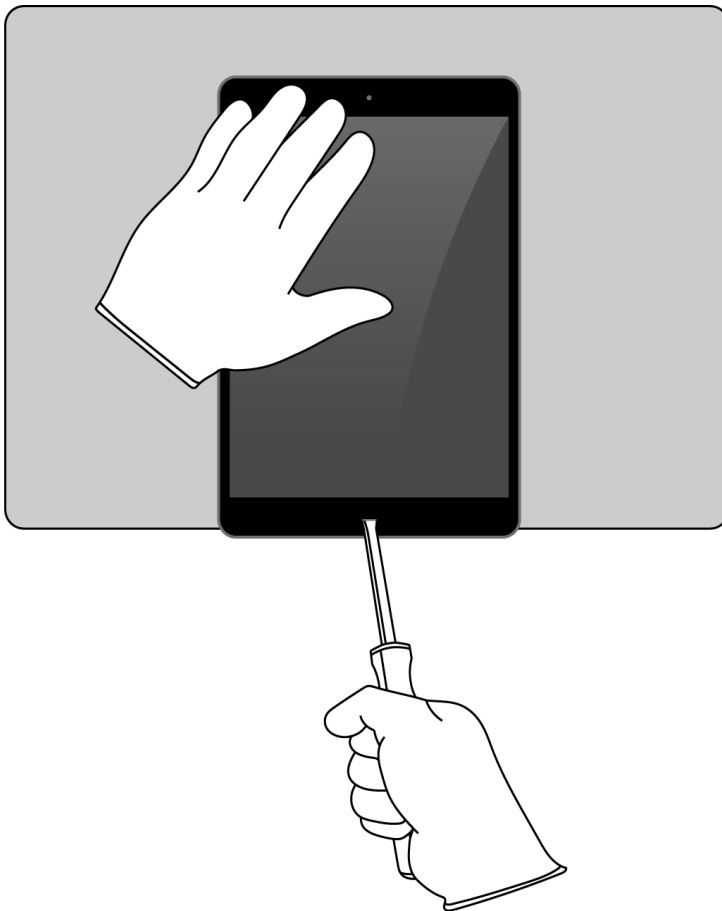
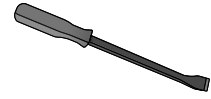

» Remove the display. Set the enclosure aside.

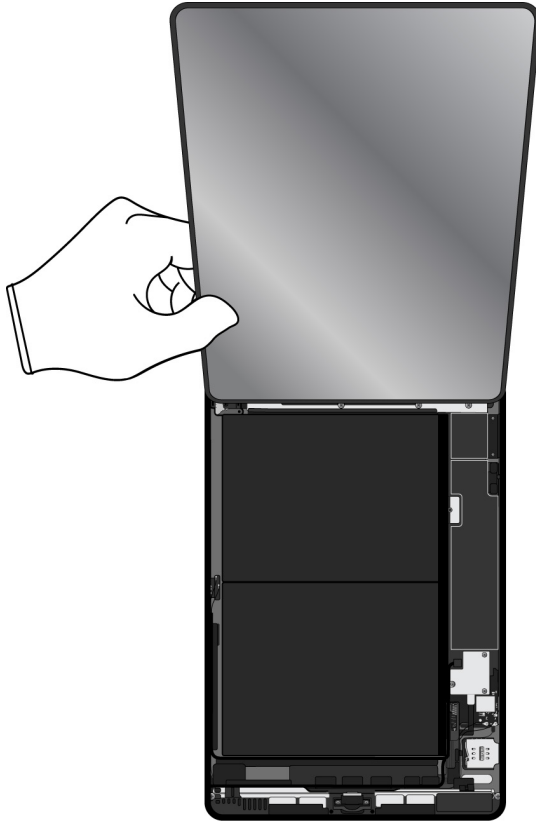

3. Remove the display logic board.

- » Lay the display face down.
- » Pry off the display logic board.

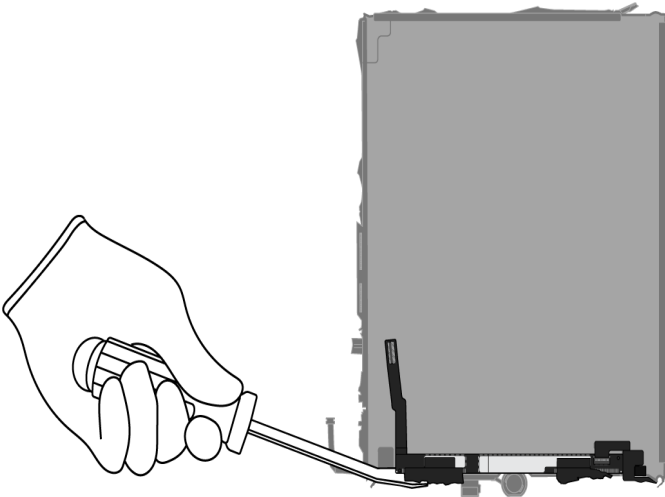

Tools Used

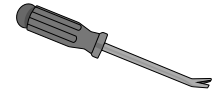

Fraction



Display logic board

PMs
Precious Metals

4. Pry off the Home button/Touch ID sensor.

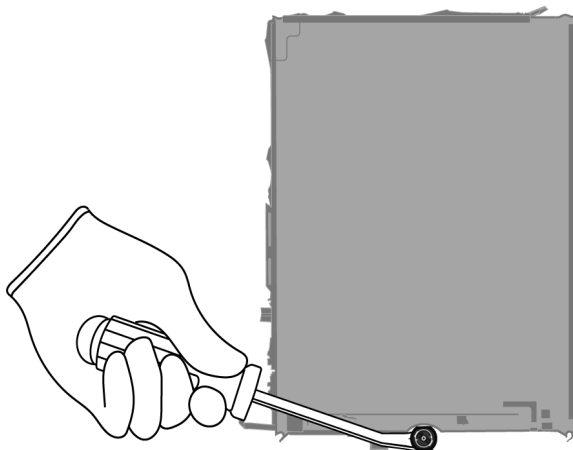

Tools Used

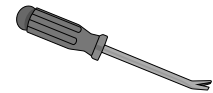

Fraction



Home button/
Touch ID sensor

Cu
Copper

5. Pry off the display cover.

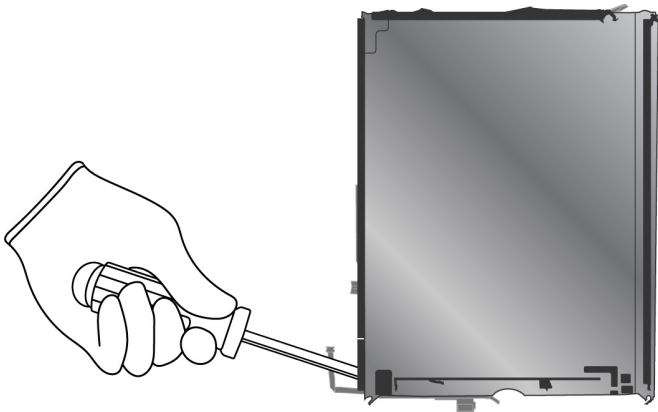

Tools Used

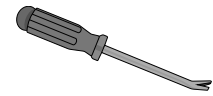

Fraction



Display cover

Fe

Ferrous

6. From the LCD cell, remove the display films.



Fraction



Display films

PL

Plastics

7. Pull the ribbon cables off the LCD cell.

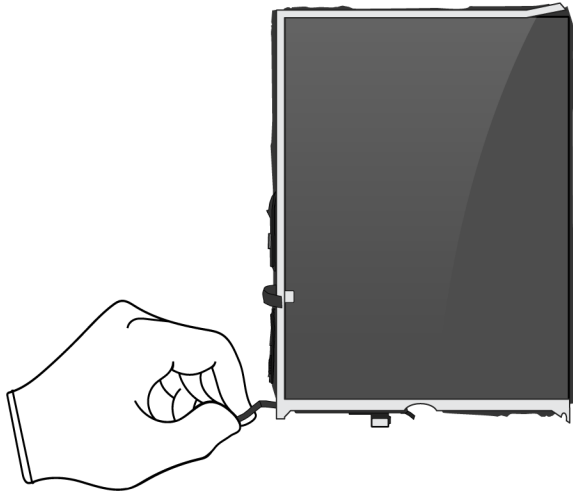

Fraction

Ribbon cables

Cu
Copper

A diagram showing a ribbon cable with a small connector. Below it is a green box with the chemical symbol 'Cu' and the word 'Copper' underneath.

Fraction

LCD cell

GL
Glass

A diagram showing a dark rectangular LCD cell. Below it is a green box with the chemical symbol 'GL' and the word 'Glass' underneath.

8. From the enclosure, gently remove both lithium-ion polymer batteries.

Rechargeable battery hazard

A yellow warning icon of a battery with a lightning bolt, followed by the text 'Rechargeable battery hazard' in a yellow-bordered box.

Tools Used

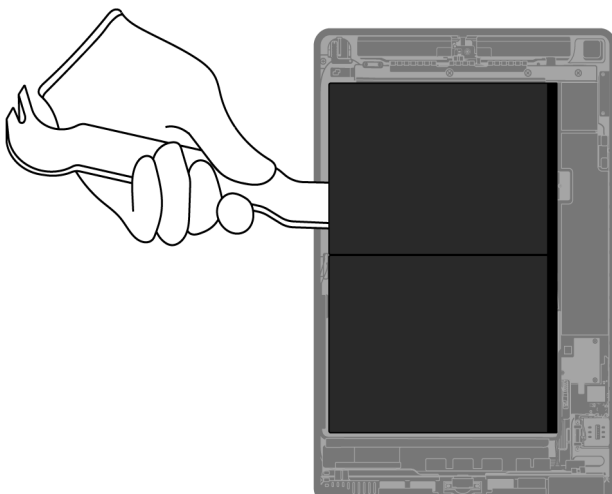
A diagram of a metal pry tool with a curved end.

Fraction

Lithium-ion polymer batteries

BT
Battery

A diagram showing two dark rectangular lithium-ion polymer batteries. Below them is a green box with the chemical symbol 'BT' and the word 'Battery' underneath.

9. Pry off the ribbon cable.

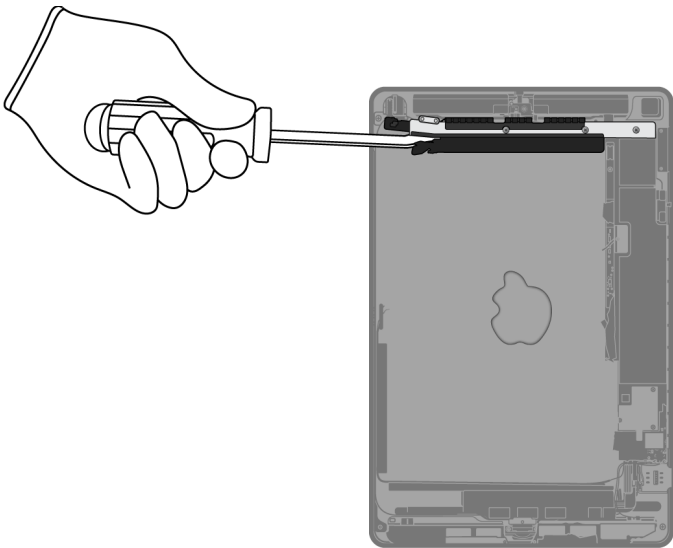

Tools Used

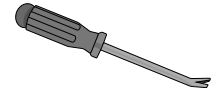

Fraction



Ribbon cable

Cu
Copper

10. Pry off the main logic board.

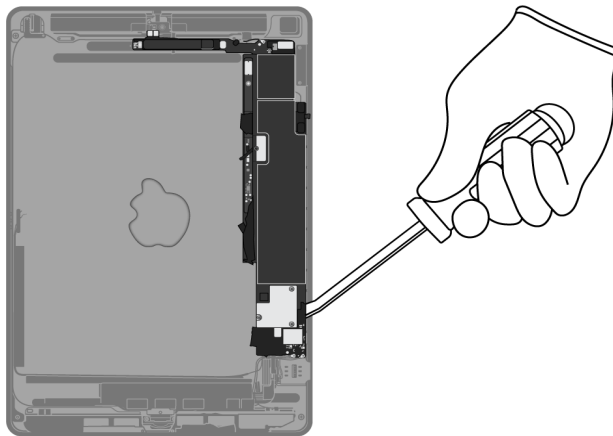

Tools Used

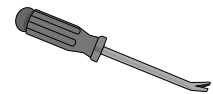

Fraction



Main logic board

PMs
Precious Metals

- 11.** (Wi-Fi + Cellular models only) Remove the SIM card and SIM tray. Separate the SIM card from the SIM tray.

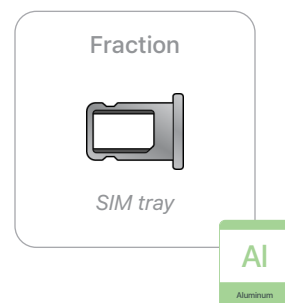
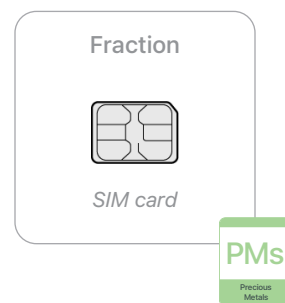
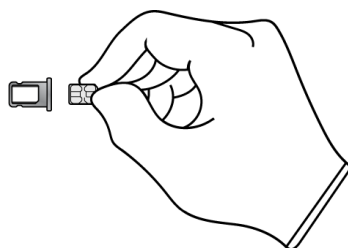
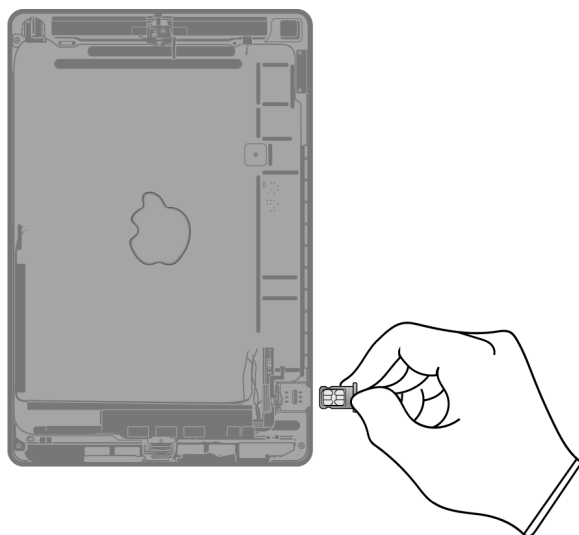

12. (Wi-Fi + Cellular models only) Pry off the SIM reader.

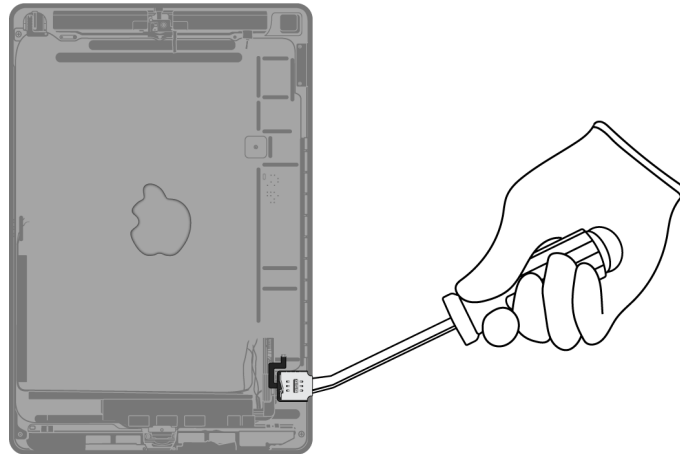

Tools Used

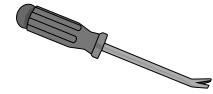

Fraction

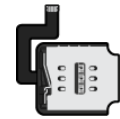

SIM reader

Cu
Copper

13. Pry off the right speaker.

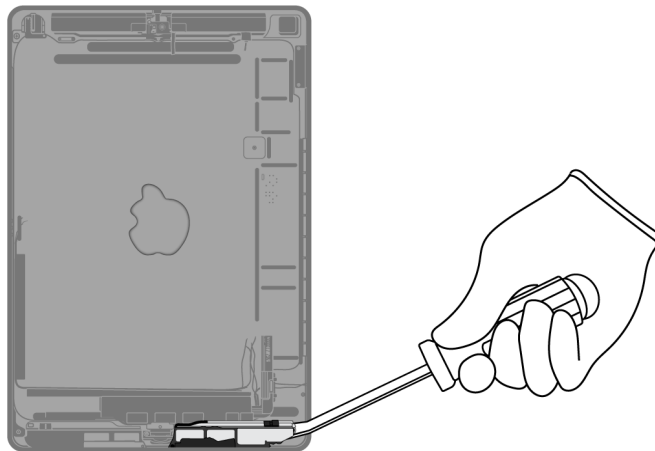

Tools Used

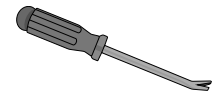

Fraction



Right speaker

REE
Rare Earth
Elements

14. Pull off the wires.

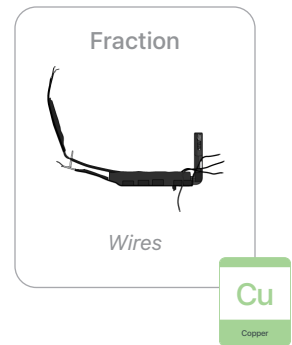
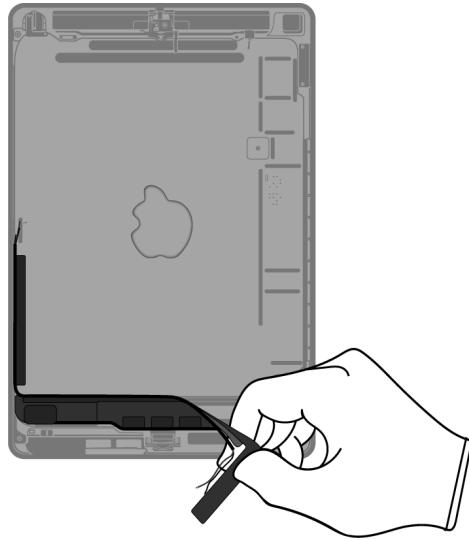

15. Pry off the Lightning connector.

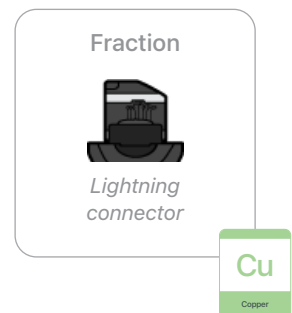
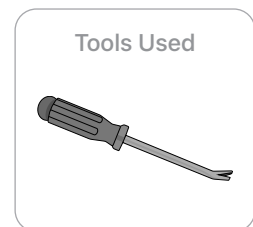
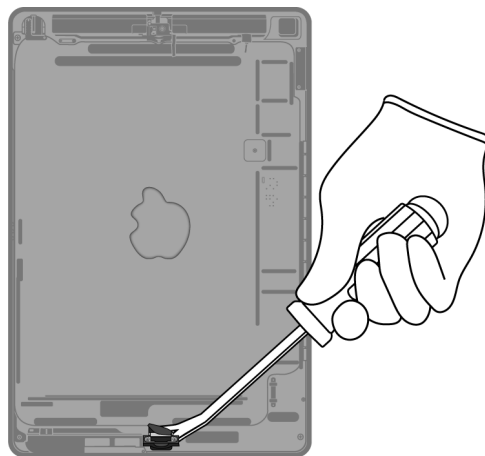

16. Pry off the left speaker.

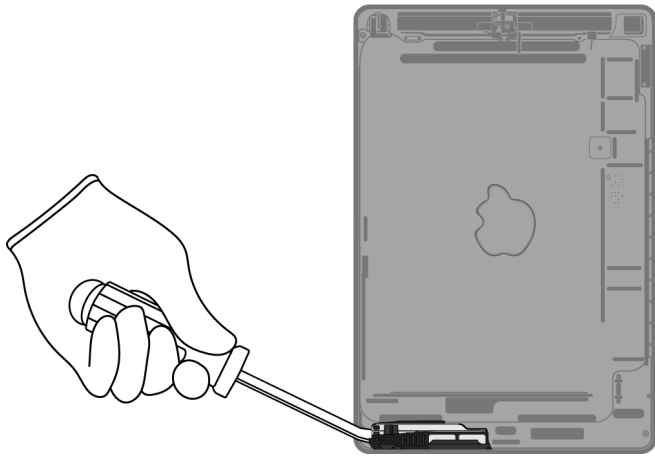

Tools Used

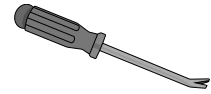

Fraction



Left speaker

REE

Rare Earth
Elements

17. Pry off the rear camera.

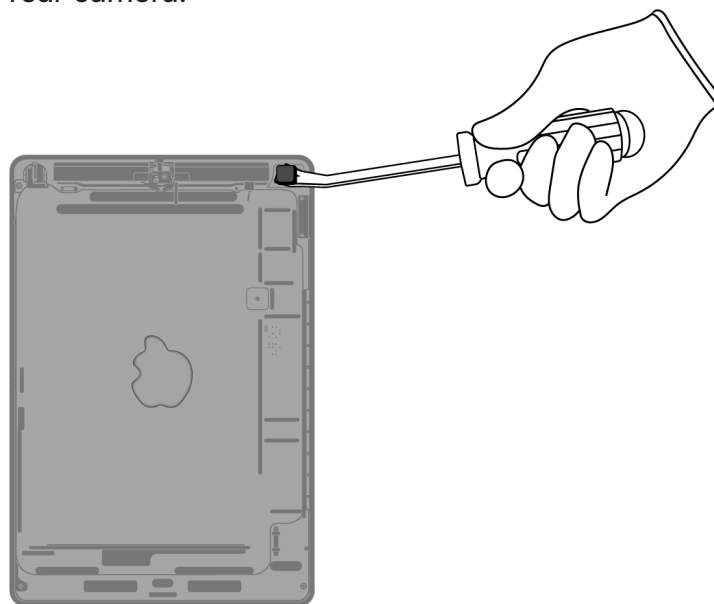

Tools Used

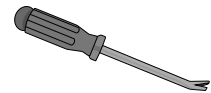

Fraction



Rear camera

PMs

Precious
Metals

18. Pry off the ribbon cable.

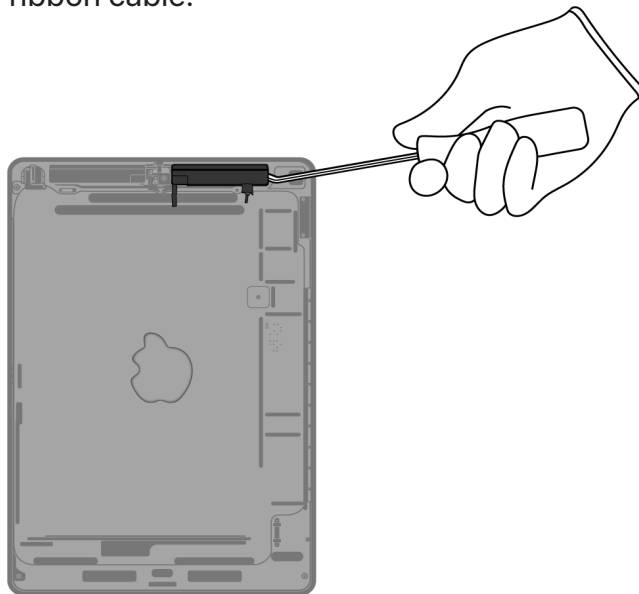

Tools Used



Fraction



Ribbon cable

Cu

Copper

19. Pry off the front camera.

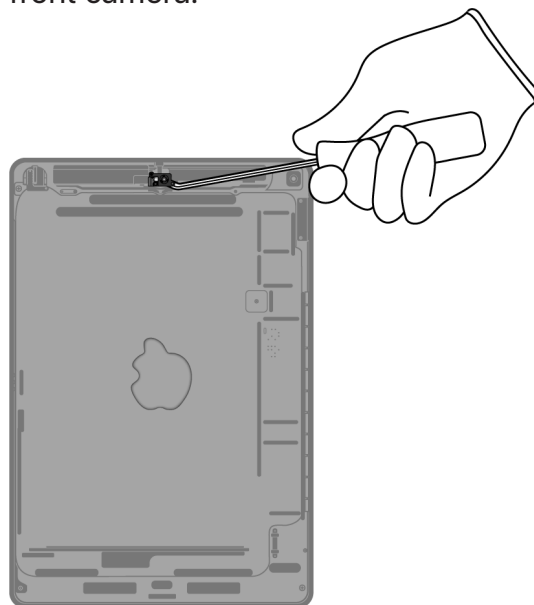

Tools Used



Fraction



Front camera

PMs

Precious Metals

20. Pry off the microphone array.

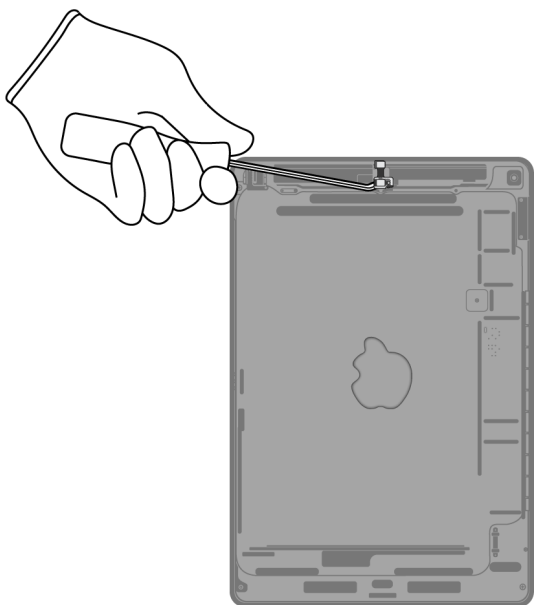

Tools Used



Fraction



Microphone array



21. Pry off the ribbon cable.

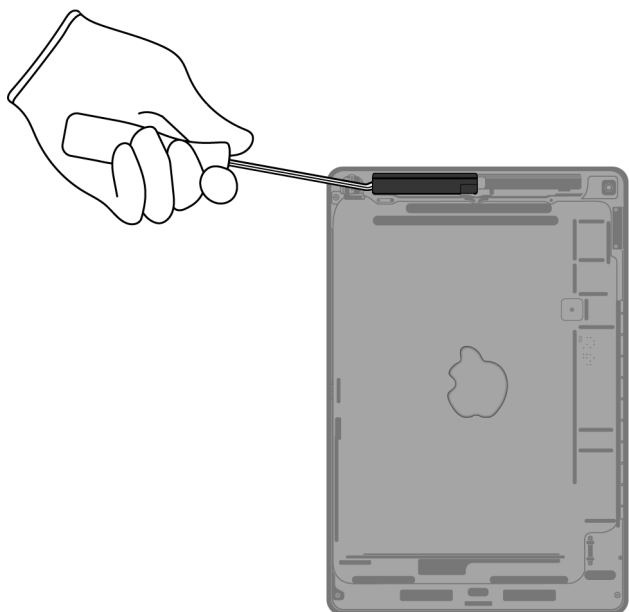

Tools Used



Fraction



Ribbon cable



22. Pry off the headphone jack.

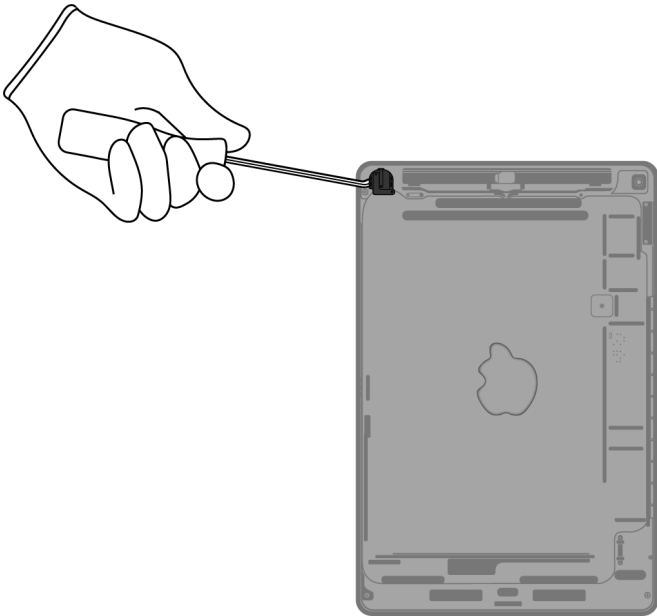

Tools Used



Fraction



Headphone jack

Cu

Copper

23. Remove the magnets.

» Bend both sides of the enclosure.

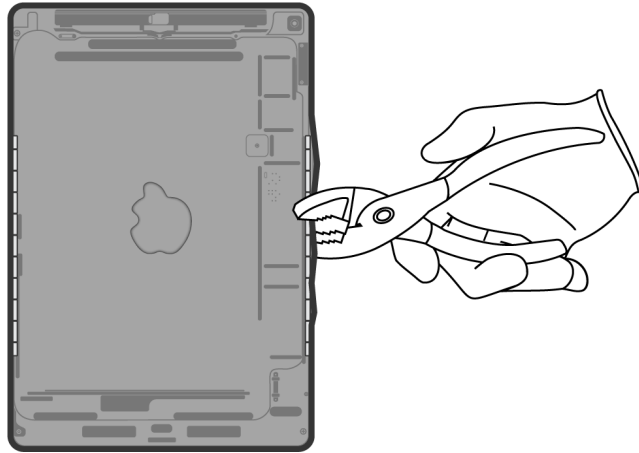

» Pry off the 24 magnets along both sides of the enclosure.

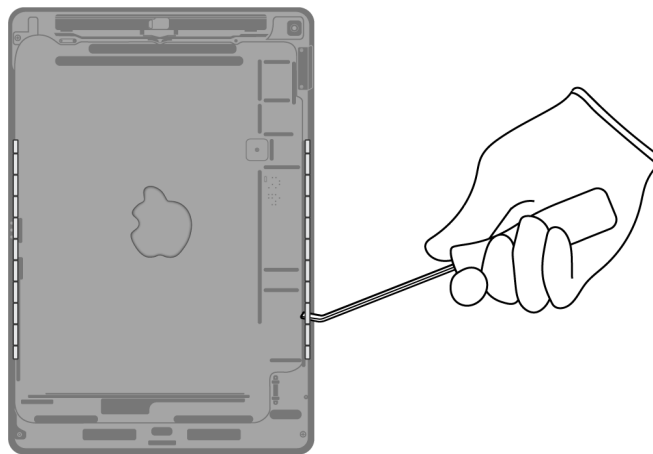

Tools Used

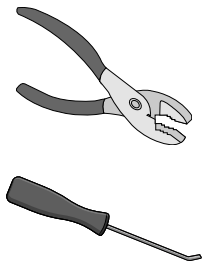

Fraction

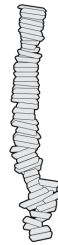

Magnets (x24)

REE

Rare Earth
Elements

Fraction









Enclosure

Al

Aluminum

Material Categorization of Output Fractions

All outputs from this process must be managed, handled, and disposed of in accordance with applicable waste laws and regulations, including but not limited to the Waste Framework Directive and its national enactments in Europe.

Fraction	Downstream Processing
<p data-bbox="435 554 570 579">Aluminum</p>  <p data-bbox="461 718 544 743"><i>SIM tray</i></p>  <p data-bbox="451 1012 553 1037"><i>Enclosure</i></p>	<p data-bbox="964 554 1276 579">Primary Target Material</p>  <p data-bbox="1101 646 1133 672">Al</p> <p data-bbox="1101 688 1140 709">Aluminum</p>
<p data-bbox="441 1134 563 1159">Batteries</p>  <p data-bbox="360 1411 644 1436"><i>Lithium-ion polymer batteries</i></p>	<p data-bbox="964 1134 1276 1159">Primary Target Material</p>  <p data-bbox="1101 1226 1133 1251">BT</p> <p data-bbox="1101 1268 1140 1289">Battery</p>
<p data-bbox="448 1533 557 1558">Ferrous</p>  <p data-bbox="435 1810 571 1835"><i>Display cover</i></p>	<p data-bbox="964 1533 1276 1558">Primary Target Material</p>  <p data-bbox="1101 1621 1133 1646">Fe</p> <p data-bbox="1101 1663 1140 1684">Ferrous</p>

Fraction

Downstream Processing

Glass



LCD cell

Primary Target Material



Potential Additional Materials



Logic Boards

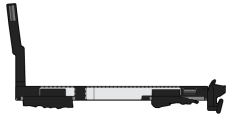

Display logic board



Main logic board



SIM card



Rear camera

Primary Target Material



Potential Additional Materials



Logic Boards (cont.)



Front camera

Mixed Electronics



Power adapter

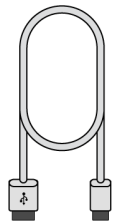

Charge cable



Home button/Touch ID sensor

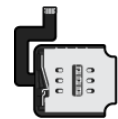

SIM reader

Primary Target Material



Potential Additional Materials



Mixed Electronics (cont.)

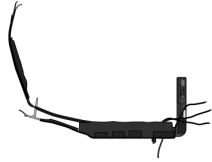

Wires



Lightning connector



Microphone array



Ribbon cables



Headphone jack

Fraction

Downstream Processing

Mixed Plastics



Display films

Primary Target Material



Rare Earth Magnets



Right speaker



Left speaker



Magnets (x24)

Primary Target Material



Potential Additional Materials

