



MagSafe Battery Pack

Apple Recycler Guide

May 2023

Contents

3	About This Guide
4	Identification
5	Directive 2012/19/EU Annex VII Components
6	Safety Considerations
8	Recommended Tools
9	Disassembly Instructions
17	Material Categorization of Output Fractions

About This Guide

Apple Recycler Guides provide guidance for electronics recyclers on how to disassemble products to maximize recovery of resources. The guides provide step-by-step disassembly instructions and information on the material composition to help recyclers direct fractions to the appropriate material recycler.

To conserve important resources, we work to reduce the materials we use and aim to one day source only recycled or renewable materials in our products. A key path to reaching that goal is resource recovery from end-of-life electronics.

Disassembly procedures are intended to be performed only by trained electronics recycling professionals. The recycler is responsible for independently evaluating and ensuring compliance with all applicable environmental, health, and safety laws related to the work. These include but are not limited to laws relating to the management, handling, shipping, and disposal of the outputs of this work as waste and laws in place to ensure the health and safety of all employees who support this work.

For questions or feedback about this guide, email contactesci@apple.com.

Identification

You can find the model number of the MagSafe Battery Pack below the magnetic ring.

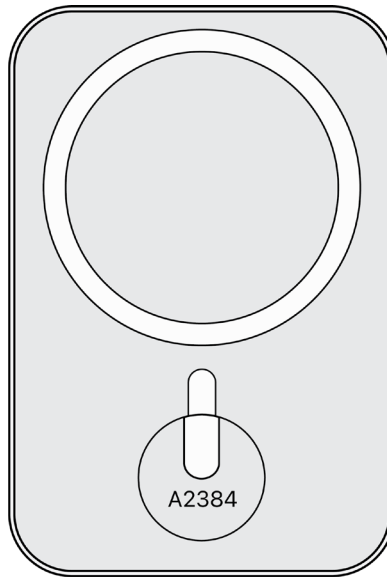

Model number:
A2384

Directive 2012/19/EU Annex VII Components

Directive 2012/19/EU Annex VII requirements apply to the following substances and components.

Substance/Component	Apple Part Name	Removal Instructions
Printed circuit board if the surface is greater than 10 square centimeters	Main logic board	Follow steps 1–6
Battery	Lithium-ion polymer batteries	Follow steps 1–7
No further substances or components as listed in Annex VII		

Safety Considerations

The recycler is responsible for independently evaluating all activities undertaken by its employees to perform or support the work and ensuring compliance with all applicable health and safety laws related to the work. These include but are not limited to laws relating to the health and safety of all employees who perform or support this work. The recycler is also responsible for evaluating the workspace and ensuring that the area in which the work is to be undertaken is designed using ergonomic best practices and meets all ergonomic requirements to ensure the protection of its employees.

Personal Protective Equipment

Personal protective equipment should be worn during the entire recycling process.



Wear hand protection



Wear protective clothing



Wear eye protection



Wear foot protection

Battery Safety

This product uses a lithium-ion polymer battery. Before beginning any disassembly work, ensure that a safe working procedure for handling lithium-ion batteries has been established, which could include discharging the batteries so that they can be more safely managed. The following considerations may also be included:

- Remove anything from your person that could conduct energy, such as jewelry and watches, to avoid electric shock to yourself or the logic board.
- To avoid the potential for thermal runaway and the release of potentially noxious fumes, don't puncture, strike, or crush lithium-ion polymer batteries or devices powered by them.
- Don't throw, drop, or bend the battery.
- Don't expose the battery to excessive heat or sunlight.
- Don't use tools that are sharp or conduct electricity.
- Keep your workspace clear of foreign objects and sharp materials.
- Dispose of batteries according to local environmental laws and guidelines.

Workspace safety guidelines

- Use heat-resistant gloves and safety glasses.
- Keep a sand dispenser within arm's reach (2 feet or 0.6 m) on one side of the workstation, not above the workstation. The dispenser should be a wide-mouthed, quick-pour metal container with a flip-top lid or tray that contains 8–10 cups (1.9–2.4 L) of clean, dry, untreated sand.
- Keep the battery at least 2 feet (0.6 m) from paper and other combustible materials.
- Work in an area with adequate ventilation.

Handling a thermal runaway

If you notice any of the following signs, a thermal runaway is likely underway, and you should act immediately:

- The lithium-ion polymer battery or a device containing one begins to smoke or emit sparks or soot.
- The battery pouch suddenly and quickly puffs out.
- You hear hissing or popping sounds.

Don't use water or an ABC/CO₂ fire extinguisher on a thermal runaway battery or a device containing one. Water and ABC/CO₂ fire extinguishers will not stop the reaction.

Do smother the battery or device immediately with plenty of clean, dry sand, dumped all at once. Timing is critical; the faster you pour all the sand, the faster the thermal runaway will stop.

Do leave the room for 30 minutes if the thermal runaway causes any irritation.

Do wait 30 minutes before touching the battery. Wear heat-resistant gloves and safety glasses to remove the battery from the sand, or use a touchless thermometer to measure the battery temperature. Only touch the battery when the event has finished.

Do dispose of the damaged battery or device (including any debris removed from the sand) according to local environmental laws and guidelines.

Hazard Warning



Rechargeable battery hazard

Recommended Tools

Miniature plastic pry bar

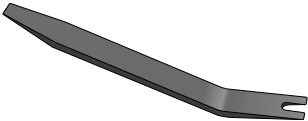

Miniature pry bar

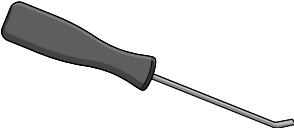

Precision slotted screwdriver

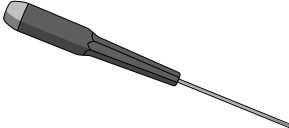

Disassembly Instructions

1. Pry off the enclosure cover. Set the enclosure aside.

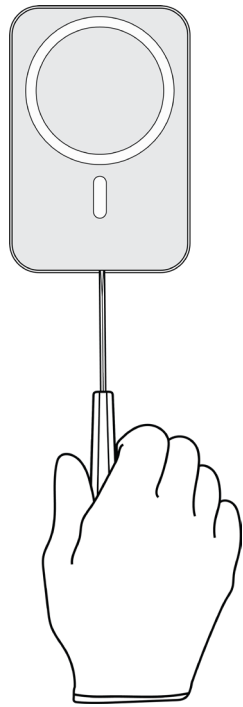

2. Pry off the magnet.

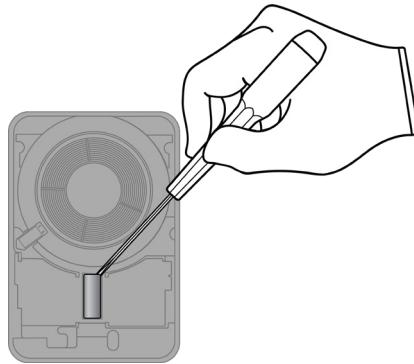

Tools Used

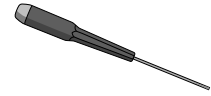

Fraction



Magnet

REE

Rare Earth
Elements

Fraction

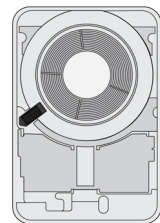

Enclosure cover

Cu

Copper

3. From the enclosure, remove the magnetic ring.

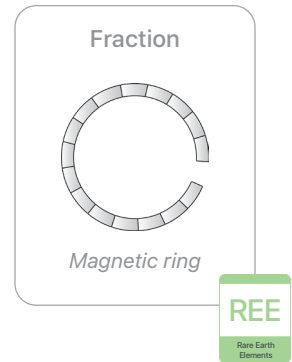
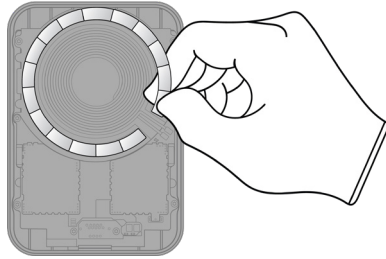

4. Pry off the main logic board module. Set the enclosure aside.

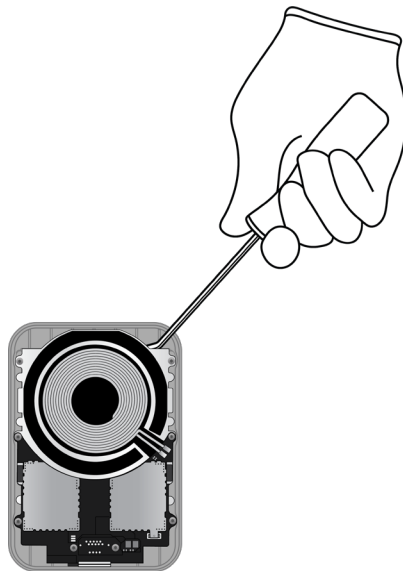

5. Pry off the coil.

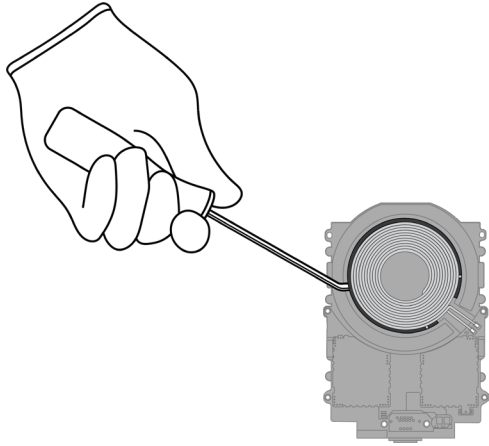

Tools Used



Fraction



Coil

Cu

Copper

6. Pry the main logic board off the thermal shield.

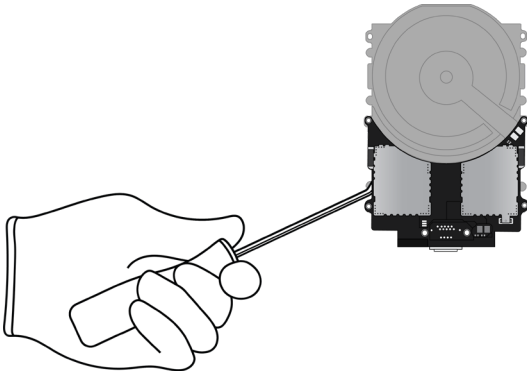

Tools Used

A simple line drawing of a screwdriver with a dark handle and a metal shaft.

Fraction

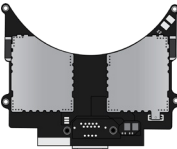
A line drawing of the main logic board, which is a rectangular circuit board with various components and connectors.

Main logic board

PMs
Precious Metals

Fraction

A line drawing of the thermal shield, which is a circular metal component with a central hole and a small protrusion.

Thermal shield

Fe
Ferrous

7. From the enclosure, carefully remove the lithium-ion polymer batteries.



Rechargeable battery hazard

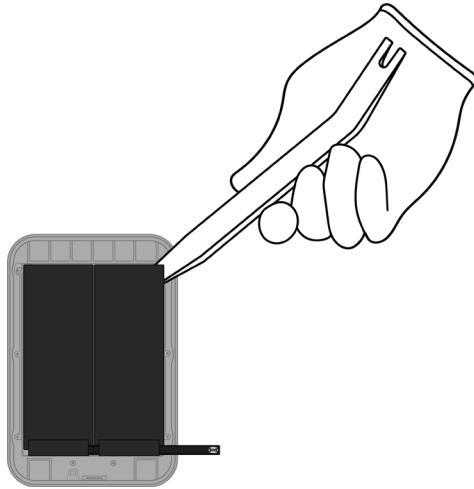

Tools Used

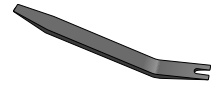

Fraction



Lithium-ion polymer batteries (x2)

BT

Battery

8. Pry off the status LED.

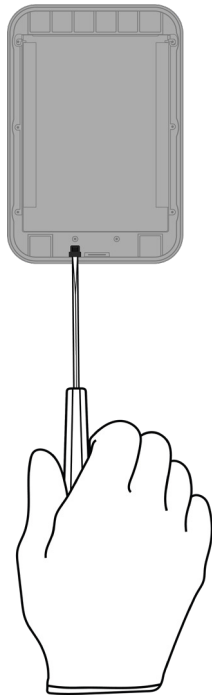

Tools Used

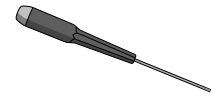

Fraction



Status LED

Cu
Copper

9. Pry off the thermal foil.

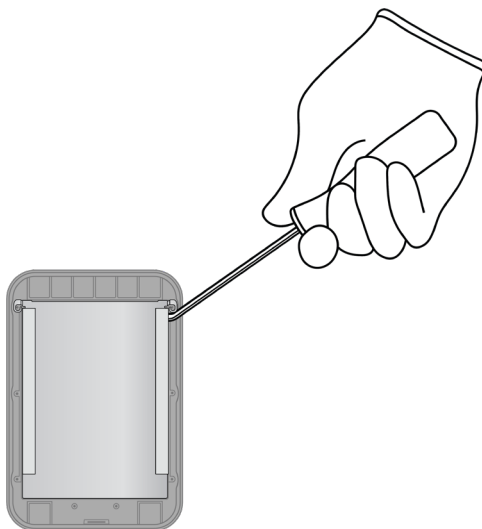

Tools Used



Fraction

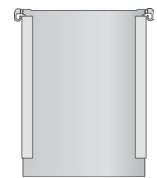

Thermal foil

Cu
Copper

10. Pry off the Lightning connector cover.

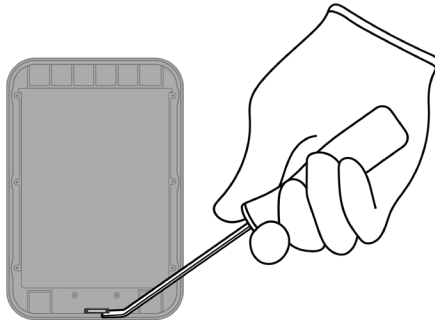

Tools Used



Fraction



Lightning connector cover

Fe

Ferrous

Fraction



Enclosure

PL

Plastics

Material Categorization of Output Fractions

All outputs from this process must be managed, handled, and disposed of in accordance with applicable waste laws and regulations, including but not limited to the Waste Framework Directive and its national enactments in Europe.

Fraction	Downstream Processing
----------	-----------------------

Batteries



Lithium-ion polymer batteries (x2)

Primary Target Material



Ferrous



Thermal shield



Lightning connector cover

Primary Target Material



Potential Additional Materials



Fraction

Downstream Processing

Logic Boards

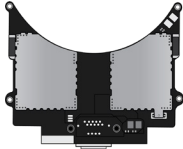

Main logic board

Primary Target Material



Potential Additional Materials



Mixed Electronics

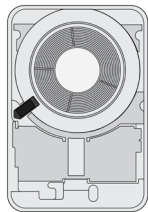

Enclosure cover

Primary Target Material



Potential Additional Materials



Coil



Status LED

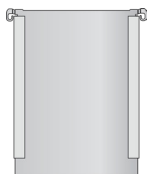

Thermal foil

Fraction

Downstream Processing

Mixed Plastics



Enclosure

Primary Target Material



Rare Earth Magnets



Magnet

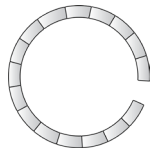

Magnetic ring

Primary Target Material

