



# Pro Display XDR

## Apple Recycler Guide

July 2023

# Contents

3	<a href="#">About This Guide</a>
4	<a href="#">Identification</a>
5	<a href="#">Directive 2012/19/EU Annex VII Components</a>
6	<a href="#">Safety Considerations</a>
7	<a href="#">Recommended Tools</a>
8	<a href="#">Disassembly Instructions</a>
20	<a href="#">Material Categorization of Output Fractions</a>

# About This Guide

Apple Recycler Guides provide guidance for electronics recyclers on how to safely disassemble products to maximize recovery of resources. The guides provide step-by-step disassembly instructions and information on the material composition to help recyclers direct fractions to the appropriate material recycler.

To conserve important resources, we work to reduce the materials we use and aim to one day source only recycled or renewable materials in our products. A key path to reaching that goal is resource recovery from end-of-life electronics.

Disassembly procedures are intended to be performed only by trained electronics recycling professionals. The recycler is responsible for independently evaluating and ensuring compliance with all applicable environmental, health, and safety laws related to the work. These include but are not limited to laws relating to the management, handling, shipping, and disposal of the outputs of this work as waste and laws in place to ensure the health and safety of all employees who support this work.

For questions or feedback about this guide, email [contactesci@apple.com](mailto:contactesci@apple.com).

## Identification

Once the stand is removed (see step 2), you can find the model number on the display inset on the back of the Pro Display XDR.



*Model number:*

*A1999*

# Directive 2012/19/EU Annex VII Components

Directive 2012/19/EU Annex VII requirements apply to the following substances and components.

Substance/Component	Apple Part Name	Removal Instructions
Printed circuit board if the surface is greater than 10 square centimeters	Display logic boards, light-emitting diode (LED) array logic boards, main logic boards	Follow steps 1–8
Cover glass and liquid crystal display (LCD) cell if the surface is greater than 100 square centimeters	Cover glass and LCD cell	Follow steps 1–4
External electric cables	Thunderbolt 3 Pro cable, power cord	Follow step 1
No further substances or components as listed in Annex VII		

# Safety Considerations

The recycler is responsible for independently evaluating all activities undertaken by its employees to perform or support the work and ensuring compliance with all applicable health and safety laws related to the work. These include but are not limited to laws relating to the health and safety of all employees who perform or support this work. The recycler is also responsible for evaluating the workspace and ensuring that the area in which the work is to be undertaken is designed using ergonomic best practices and meets all ergonomic requirements to ensure the protection of its employees.

## Personal Protective Equipment

Personal protective equipment should be worn during the entire recycling process.



Wear hand protection



Wear a mask



Wear eye protection



Wear foot protection



Wear protective clothing

## LED Safety

Broken light-emitting diodes (LEDs) must be handled properly to ensure the safety of your employees and mitigate any hazards. Package broken LEDs in an appropriate container to properly manage the hazards associated with the materials and store only with compatible materials. All waste must be properly classified, packaged, and labeled in accordance with all relevant laws and regulations.

## Hazard Warnings



Broken glass hazard



Crushing hazard



Chemical inhalation hazard



Sharp edges—cut hazard

# Recommended Tools

Flat-blade screwdriver

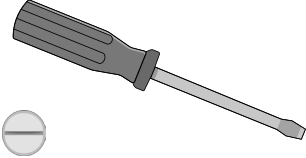

Flat surface scraper

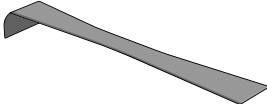

Heavy chisel

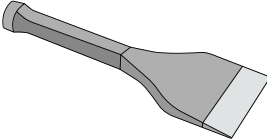

Mallet

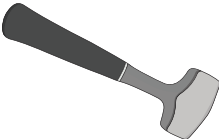

Nail-pulling screwdriver

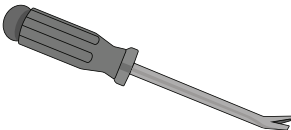

# Disassembly Instructions

1. Unplug the power cable and the Thunderbolt 3 Pro cable from behind the display.

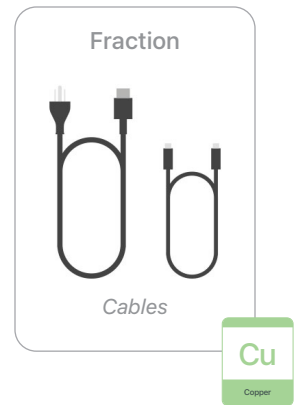

**Warning:** Before continuing disassembly, wait 10 minutes after unplugging the device for stored energy to discharge.



2. Remove the stand. Depending on the type of stand, follow the appropriate substep.

» (Pro Stand) Detach the Pro Display XDR from the Pro Stand.

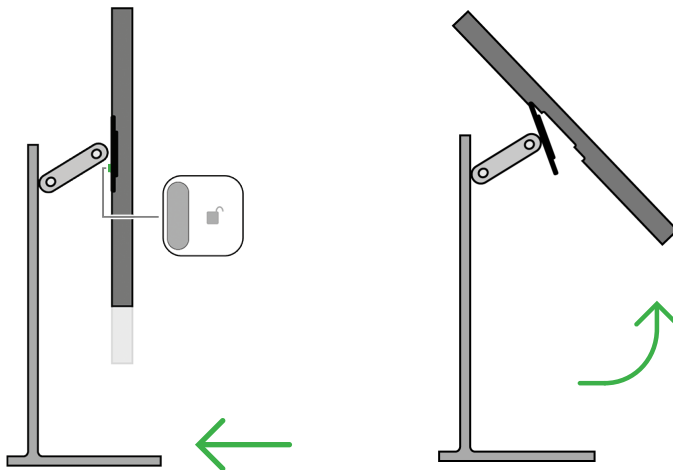
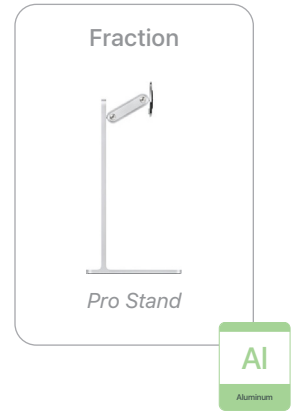
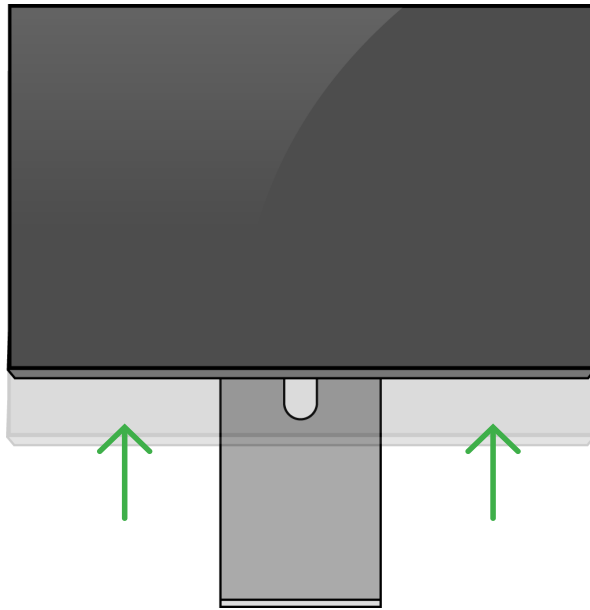

» (VESA Mount Adapter) Detach the Pro Display XDR from the VESA Mount Adapter.

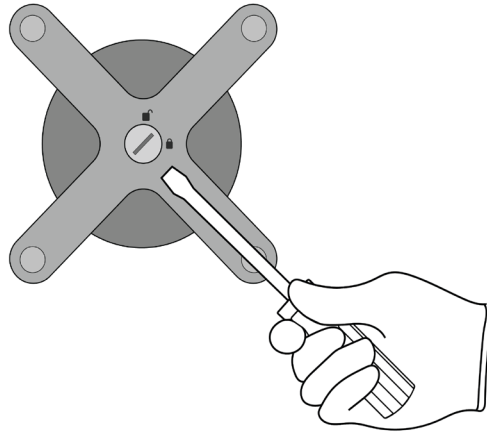

Tools Used

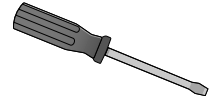

Fraction

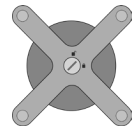

VESA Mount Adapter

Al

Aluminum

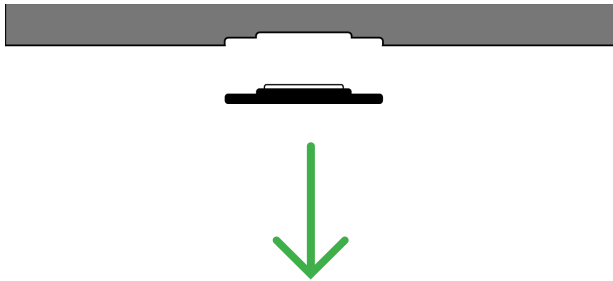

3. Pry the cover glass and LCD cell away from the display. Set the display aside.



Broken glass hazard



Chemical exposure hazard

Tools Used

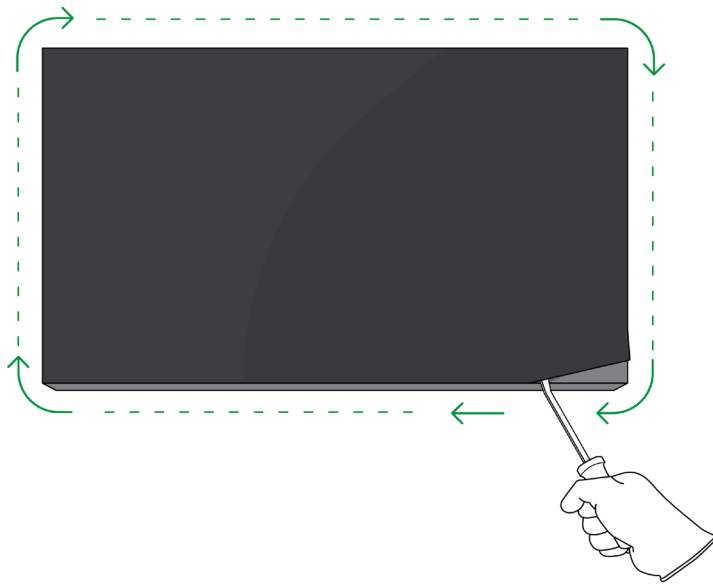
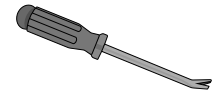

#### 4. Remove the display films from the cover glass.

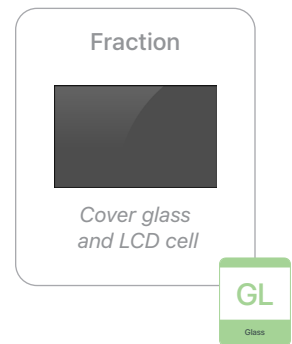
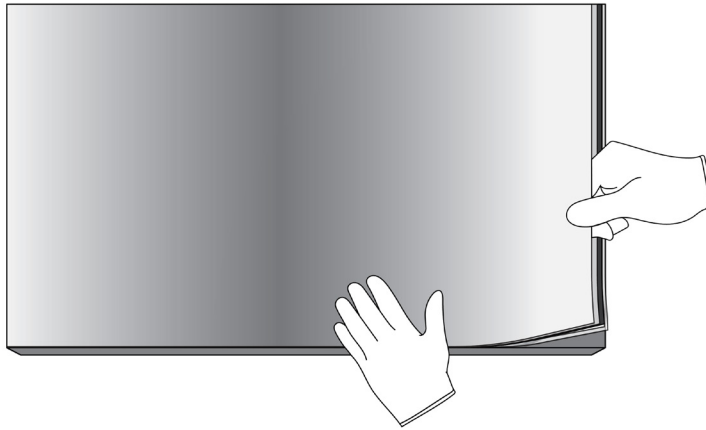

#### 5. Remove the two logic boards attached to the display.

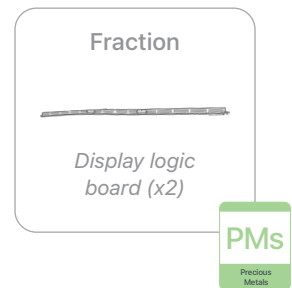
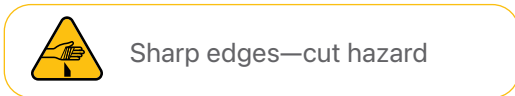

## 6. Remove the LED array.

» Pry the LED array away from the enclosure.

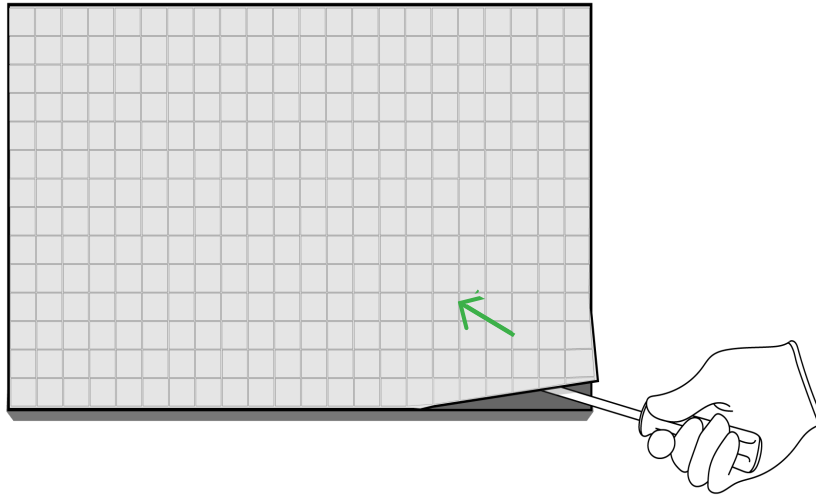

Tools Used

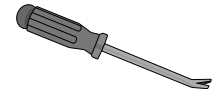

» Pull off the LED array (A) by hand. Set the enclosure (B) aside.

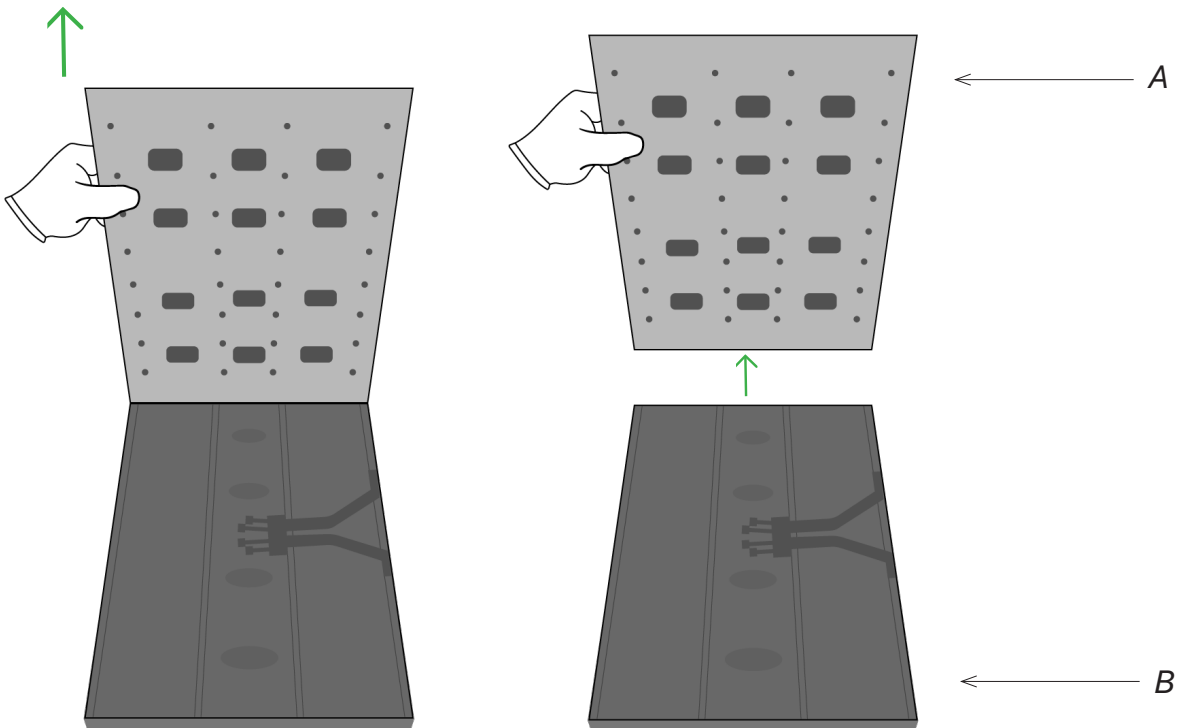

» Remove the reflector.

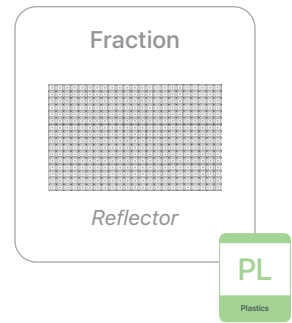
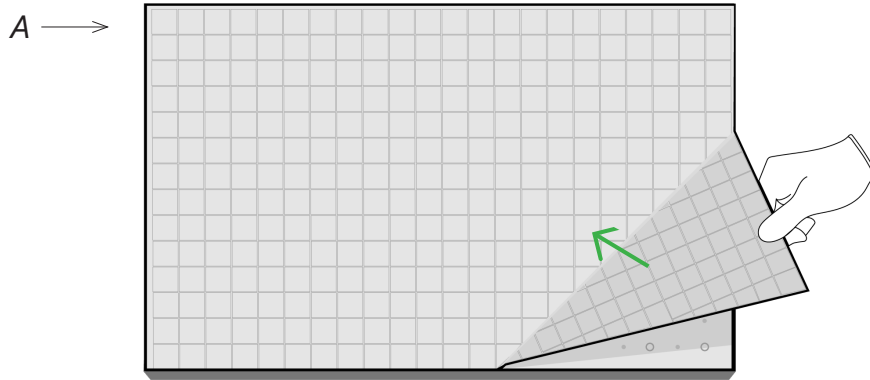

» Remove the two LED array logic boards from the mid plate.

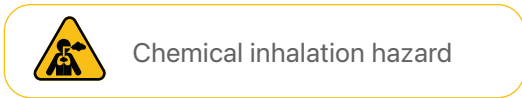

Chemical inhalation hazard

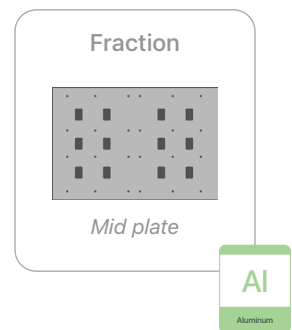
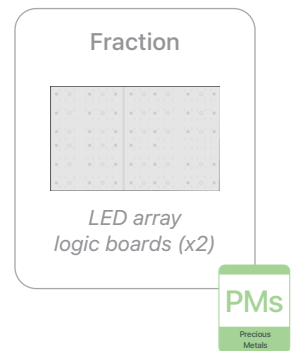
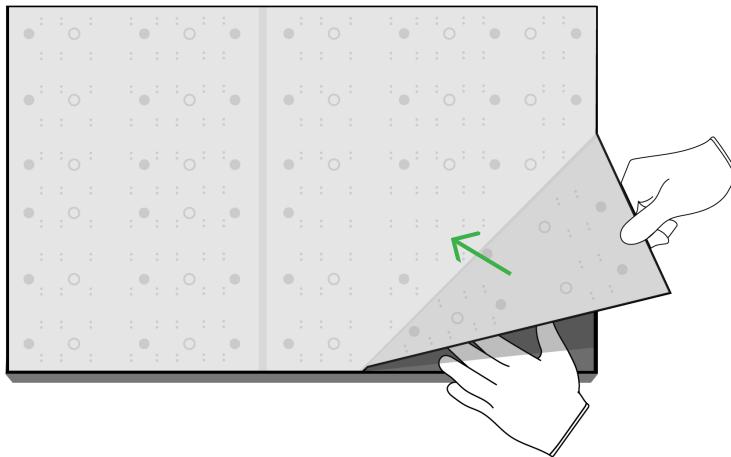

## 7. Remove the dust plates from the enclosure.

» Pull off the ribbon wires.

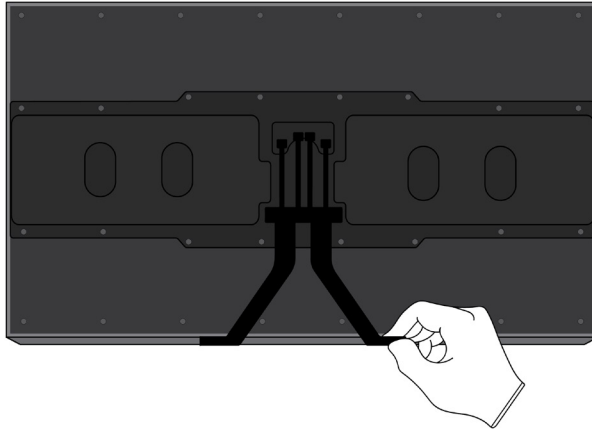

### Tools Used

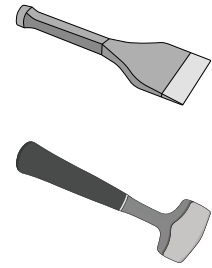

### Fraction

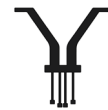

Ribbon wires

Cu

Copper

» Remove the fasteners using the mallet and chisel. Then lift off the center dust plate.



Crushing hazard

### Fraction

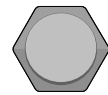

Fasteners (x35)

Fe

Ferrous

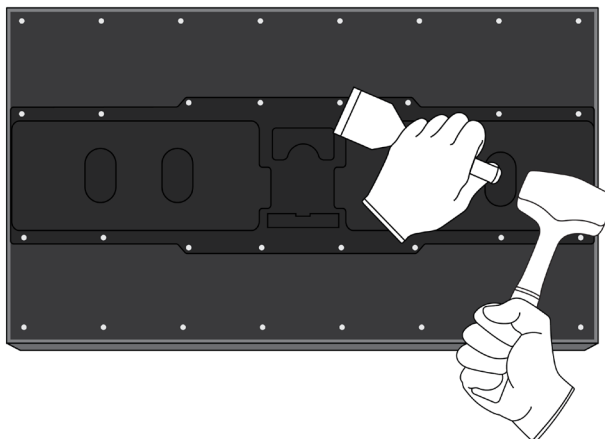

### Fraction



Center dust plate

Al

Aluminum

» Remove the side dust plates.

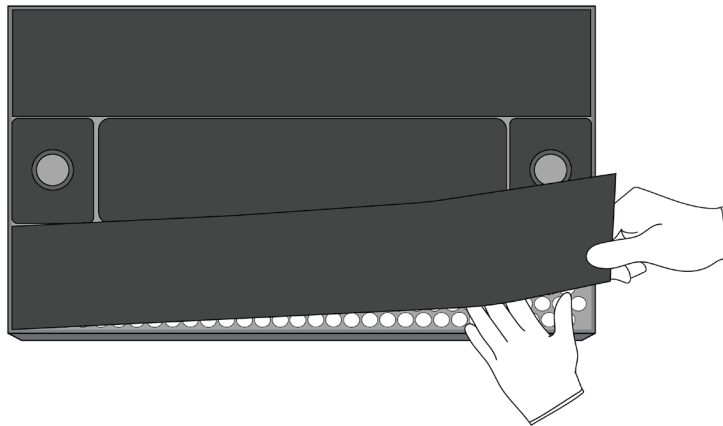

Fraction



Side dust plates

Fe

Ferrous

8. Remove the four main logic boards.

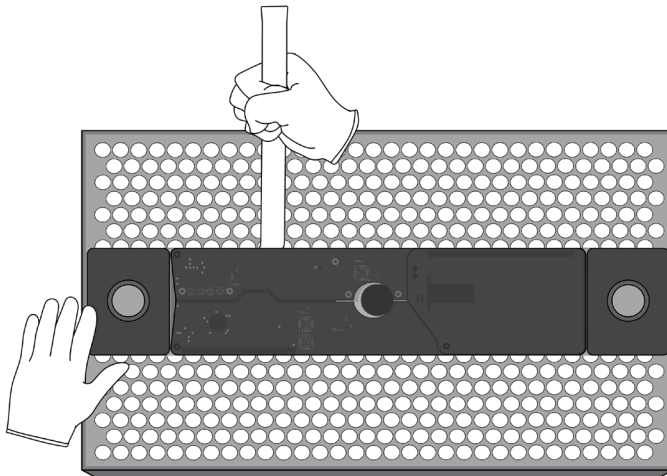

Tools Used



Fraction

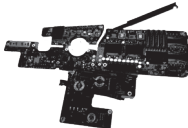

Main logic boards (x4)

PMs

Precious Metals



## 9. Remove the magnets.

» *Pry off the center magnet.*

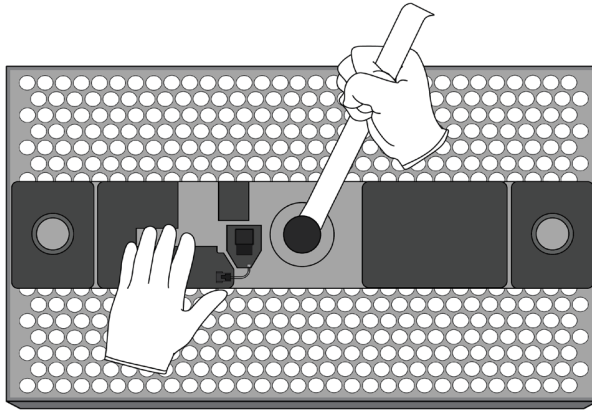

### Tools Used

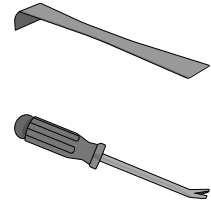

### Fraction

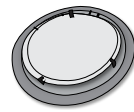

Magnet

REE

Rare Earth  
Elements

» *Pry off the four side magnets.*

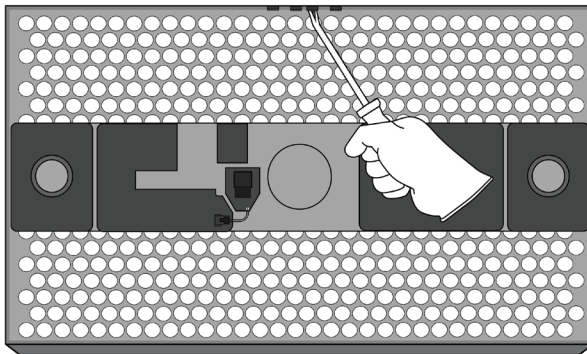

### Fraction



Magnets

REE

Rare Earth  
Elements

## 10. Remove both fans.

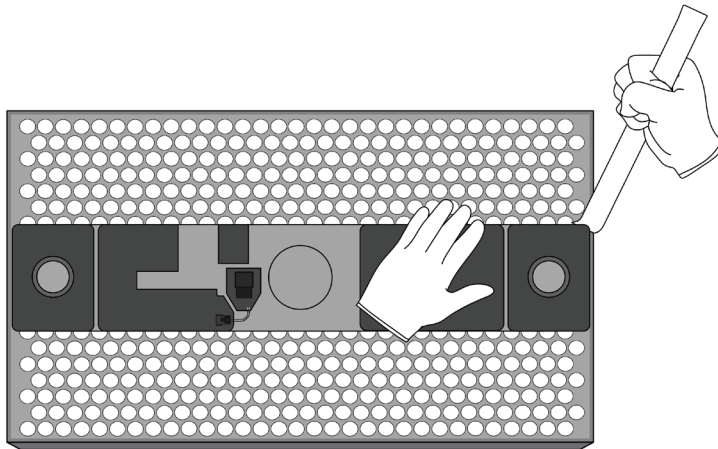

### Tools Used



### Fraction



Fans

Cu

Copper

## 11. Remove the AC power inlet.

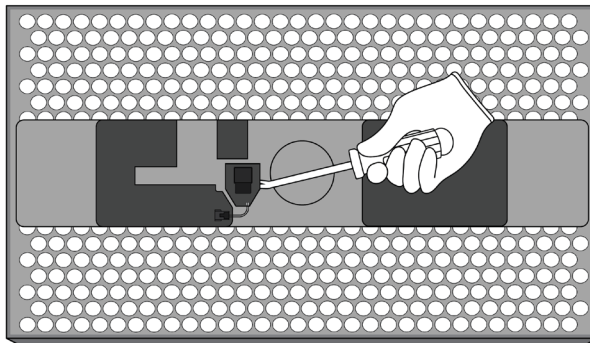

### Tools Used

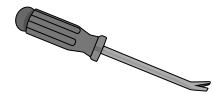

### Fraction

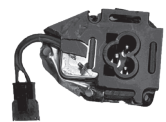

AC power inlet

Cu





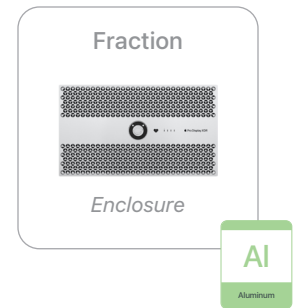
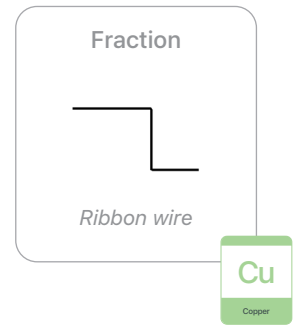
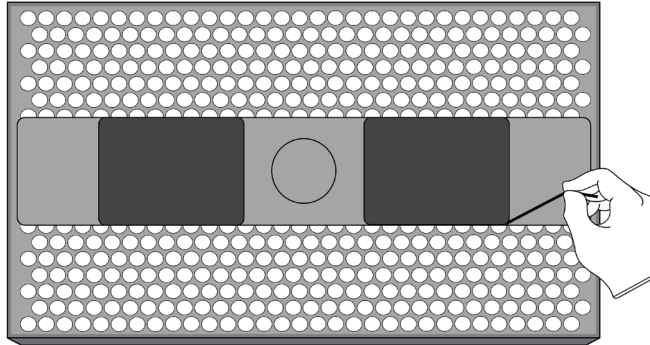

Copper

## 12. Remove the final ribbon wire.

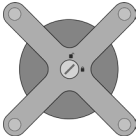
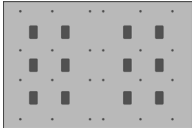

# Treatment of Output Fractions

All outputs from this process must be managed, handled, and disposed of in accordance with applicable waste laws and regulations, including but not limited to the Waste Framework Directive and its national enactments in Europe.

Fraction	Downstream Processing
<p><b>Aluminum</b></p>  <p><i>Pro Stand</i></p>  <p><i>VESA Mount Adapter</i></p>  <p><i>Mid plate</i></p>  <p><i>Center dust plate</i></p>  <p><i>Enclosure</i></p>	<p><b>Primary Target Material</b></p>  <p><b>Potential Additional Materials</b></p>   

Fraction	Downstream Processing
----------	-----------------------

**Ferrous**

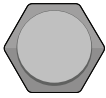

Fasteners (x35)



Side dust plates

**Primary Target Material**



**Glass**



Cover glass and LCD cell

**Primary Target Material**



**Potential Additional Materials**



**Logic Boards**



Display logic boards (x2)

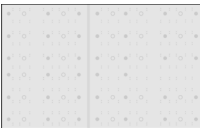

LED array logic boards (x2)

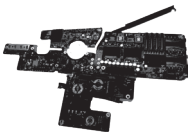

Main logic boards (x4)

**Primary Target Material**



**Potential Additional Materials**



Fraction	Downstream Processing
----------	-----------------------

**Mixed Electronics**

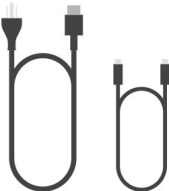

Cables



Ribbon wires



Fans and AC power inlet

**Primary Target Material**



**Potential Additional Materials**



**Mixed Plastics**

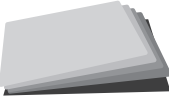

Display films

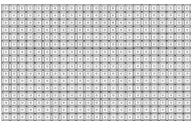

Reflector

**Primary Target Material**



**Rare Earth Magnets**

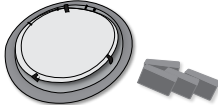

Magnets (x5)

**Primary Target Material**

