



Studio Display

Apple Recycler Guide

March 2022

Contents

- 3 [About This Guide](#)
- 4 [Identification](#)
- 5 [Directive 2012/19/EU Annex VII Components](#)
- 6 [Safety Considerations](#)
- 7 [Recommended Tools](#)
- 8 [Disassembly Instructions](#)
- 34 [Material Categorization of Output Fractions](#)

About This Guide

Apple Recycler Guides provide guidance for electronics recyclers on how to disassemble products to maximize recovery of resources. The guides provide step-by-step disassembly instructions and information on the material composition to help recyclers direct fractions to the appropriate material recycler.

To conserve important resources, we work to reduce the materials we use and aim to one day source only recycled or renewable materials in our products. A key path to reaching that goal is resource recovery from end-of-life electronics.

Disassembly procedures are intended to be performed only by trained electronics recycling professionals. The recycler is responsible for independently evaluating and ensuring compliance with all applicable environmental, health, and safety laws related to the work. These include but are not limited to laws relating to the management, handling, shipping, and disposal of the outputs of this work as waste and laws in place to ensure the health and safety of all employees who support this work.

For questions or feedback about this guide, email contactesci@apple.com.

Identification

You can find the model number of the display on the bottom of the display stand. To view the model number, hold the sides of the display and gently lay the display face down on a soft, clean towel or cloth.



Model number:
A2525

Directive 2012/19/EU Annex VII Components

Directive 2012/19/EU Annex VII requirements apply to the following substances and components.

Substance/Component	Location	Removal Instructions
Printed circuit board if the surface is greater than 10 square centimeters	Display logic board, connector logic board, light-emitting diode (LED) logic board, power supply logic board, main logic board	Follow steps 1–24
Cover glass and liquid crystal display (LCD) cell if the surface is greater than 100 square centimeters	Cover glass and LCD cell	Follow step 1–15
External electric cables	USB-C cable and power cord	Follow step 1
No further substances or components as listed in Annex VII		

Safety Considerations

The recycler is responsible for independently evaluating all activities undertaken by its employees to perform or support the work and ensuring compliance with all applicable health and safety laws related to the work. These include but are not limited to laws relating to the health and safety of all employees who perform or support this work. The recycler is also responsible for evaluating the workspace and ensuring that the area in which the work is to be undertaken is designed using ergonomic best practices and meets all ergonomic requirements to ensure the protection of its employees.

Personal Protective Equipment

Personal protective equipment should be worn during the entire recycling process.



Wear hand protection



Wear protective clothing



Wear eye protection



Wear foot protection



Wear a mask

LED Safety

Broken LEDs must be handled properly to ensure the safety of your employees and mitigate any hazards. Package broken LEDs in an appropriate container to properly manage the hazards associated with the materials and store only with compatible materials. All waste must be properly classified, packaged, and labeled in accordance with all relevant laws and regulations.

Hazard Warnings



Broken glass hazard



Chemical inhalation hazard



Chemical exposure hazard

Recommended Tools

Hammer

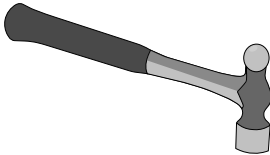

Long-nose pliers

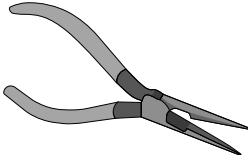

Nail-pulling screwdriver

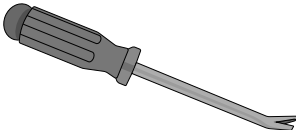

Torx® T20 screwdriver

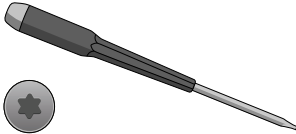

Wire cutters

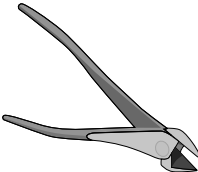

Wood chisel

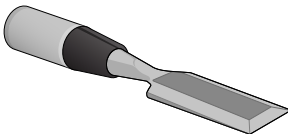

Disassembly Instructions

1. Remove the cables.

» Turn off the display.



» Unplug the USB-C cable.

» Cut off the power cable from the back of the display.

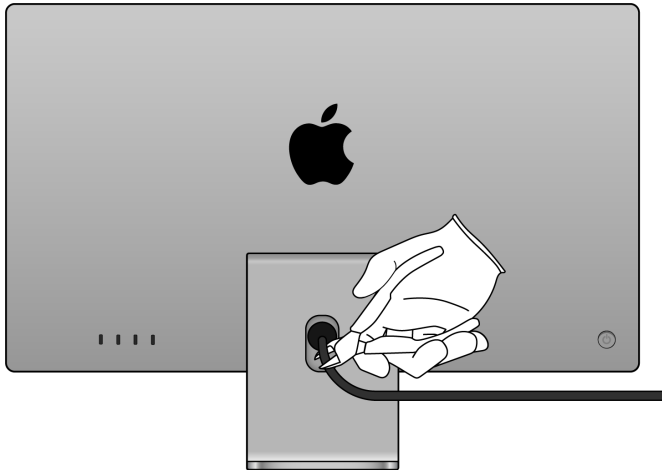

Warning: Before starting disassembly, wait 10 minutes after unplugging the device for stored energy to discharge.

Tools Used

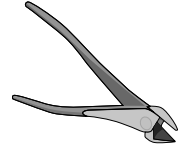

Fraction



USB-C cable

Cu

Copper

Fraction



Power cable

Cu

Copper

2. Remove the display.

» *Pry in between the cover glass and aluminum enclosure.*

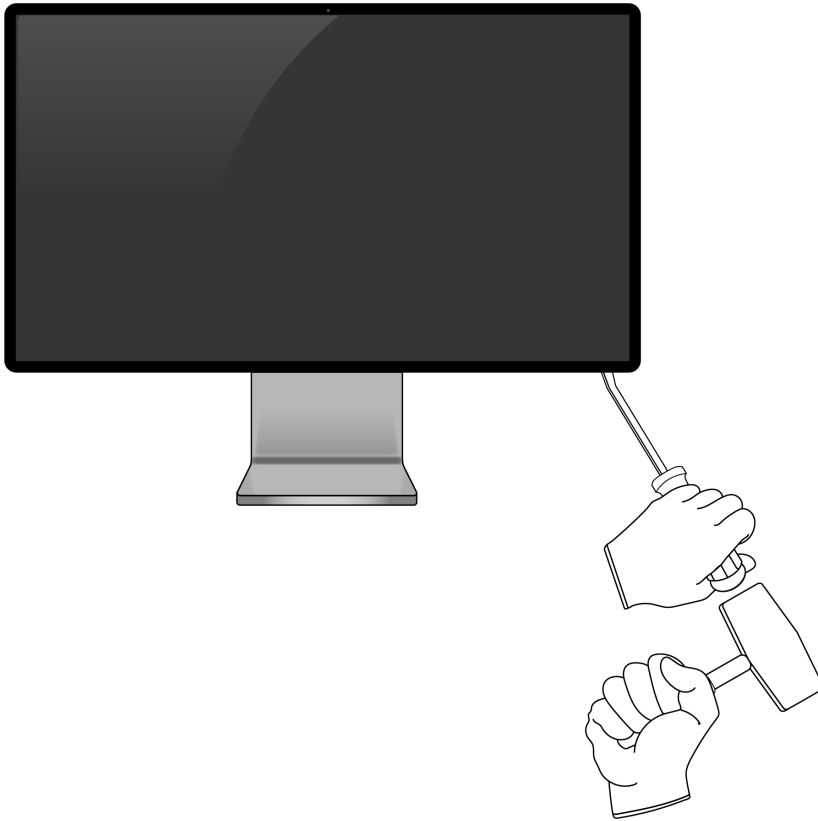

Tools Used

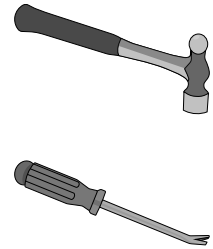

» Once under the display, slide the nail-pulling screwdriver along the right vertical edge and then along the bottom horizontal edge.



Broken glass hazard



Chemical exposure hazard

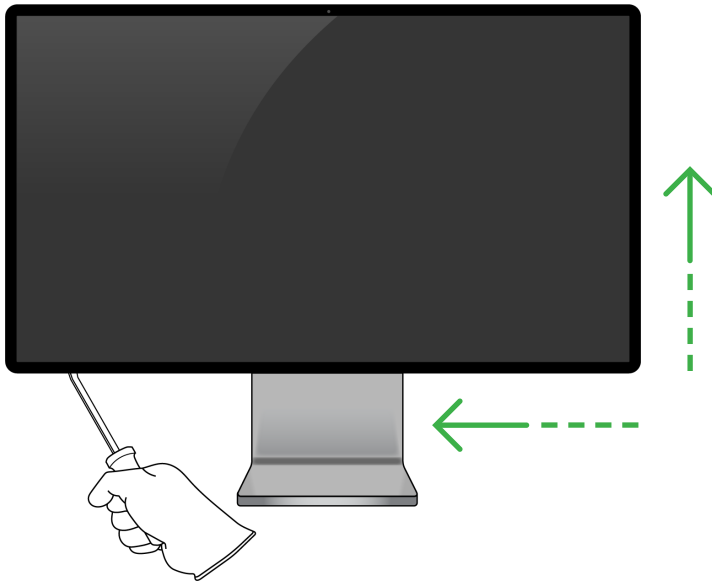

3. Separate the display and enclosure.

» *Lift up the display from the enclosure.*

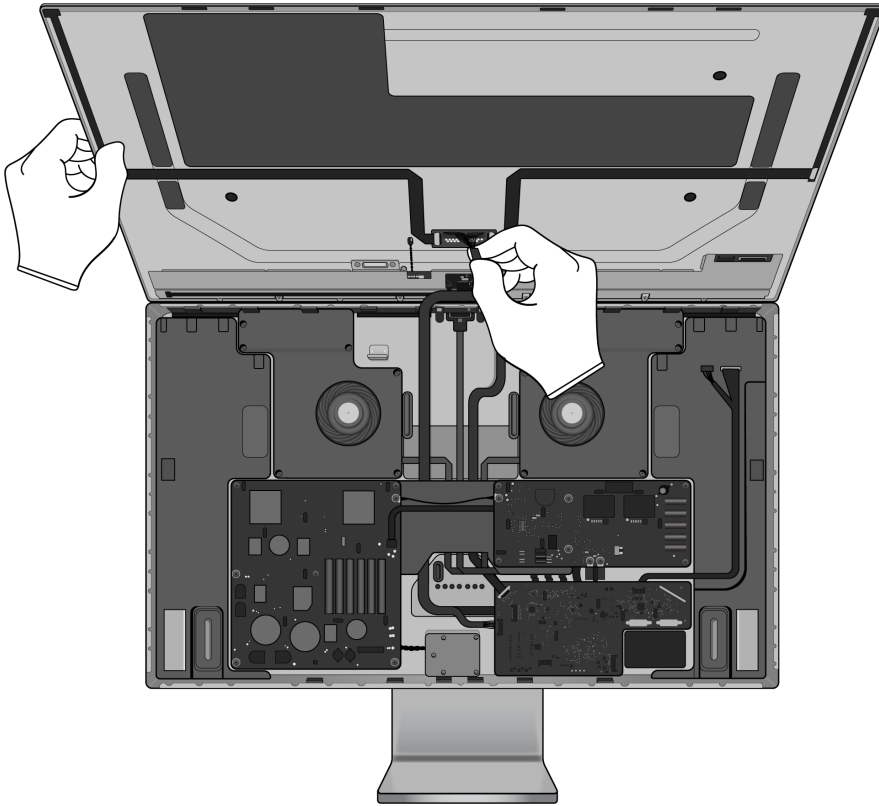

» *Unplug the ribbon cables by hand. Set the enclosure aside.*

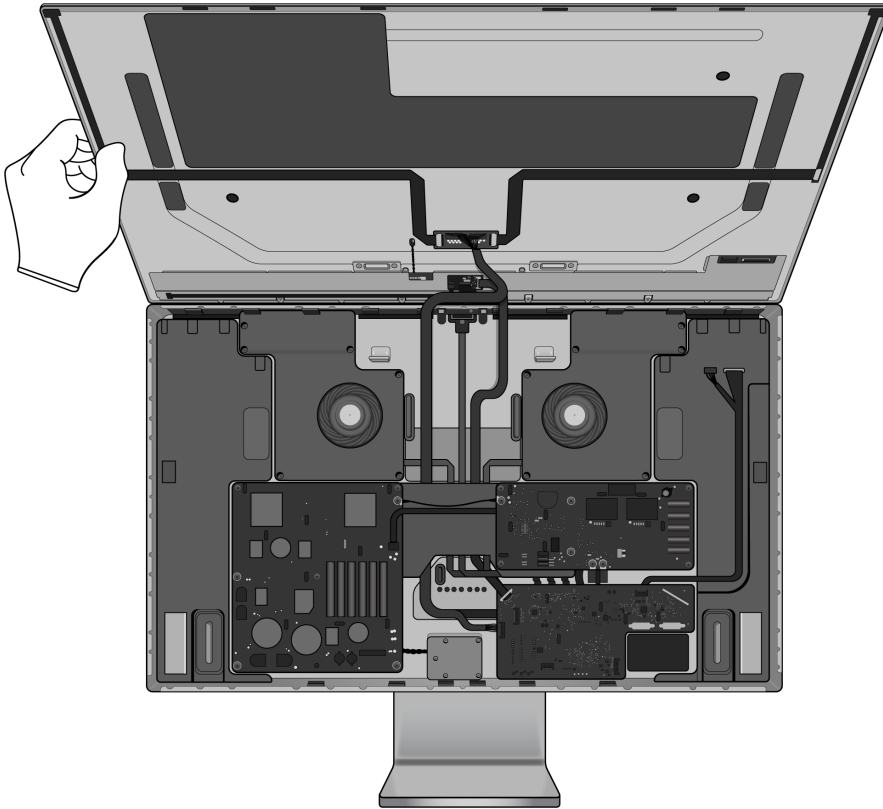

4. Pry off the display logic board cover. Set the display aside.

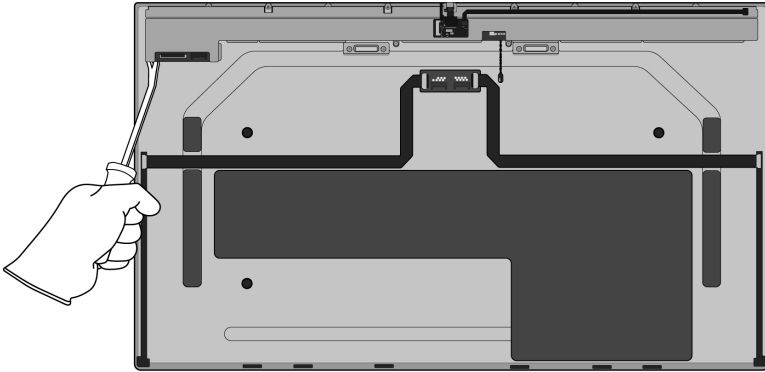

Tools Used

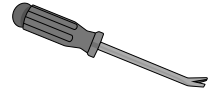

5. On the back side of the display logic board cover, pry off the camera logic board and ribbon cable.

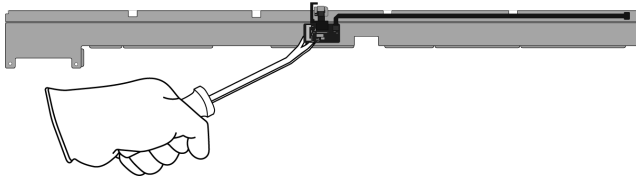

Tools Used

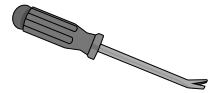

Fraction



Camera logic board
with ribbon cable

PMs

Precious
Metals

Fraction



Logic board cover

Fe

Ferrous

6. On the display, pry off the display logic board.

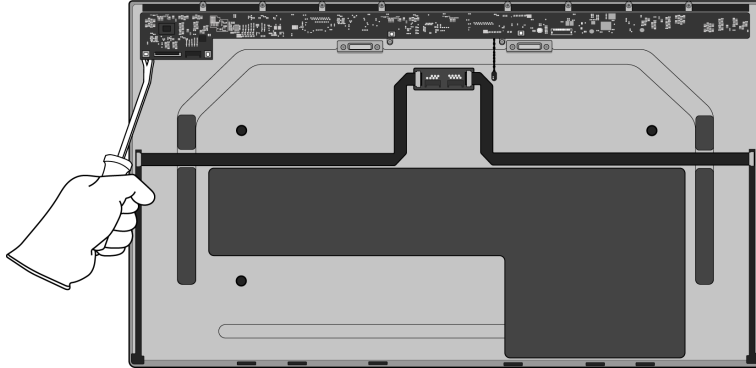

Tools Used

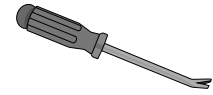

Fraction



Display logic board

PMs
Precious Metals

7. Pull off the flex cable and the two ribbon cables by hand.

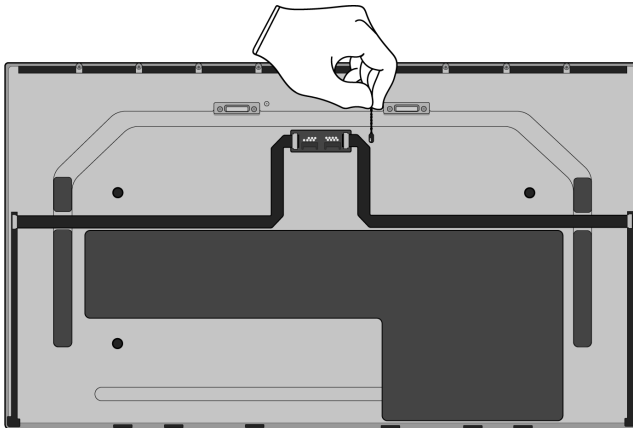

Fraction



Flex cable



Ribbon cables

Cu
Copper

8. Pry off the connector logic board.

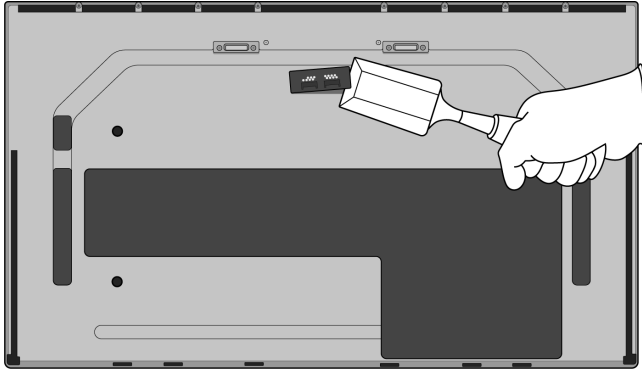

Tools Used



Fraction



Connector logic board



9. Pry up the edge of the plastic sheet. Remove it by hand.

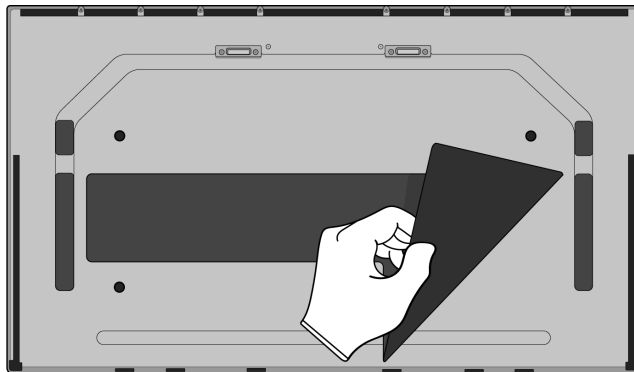
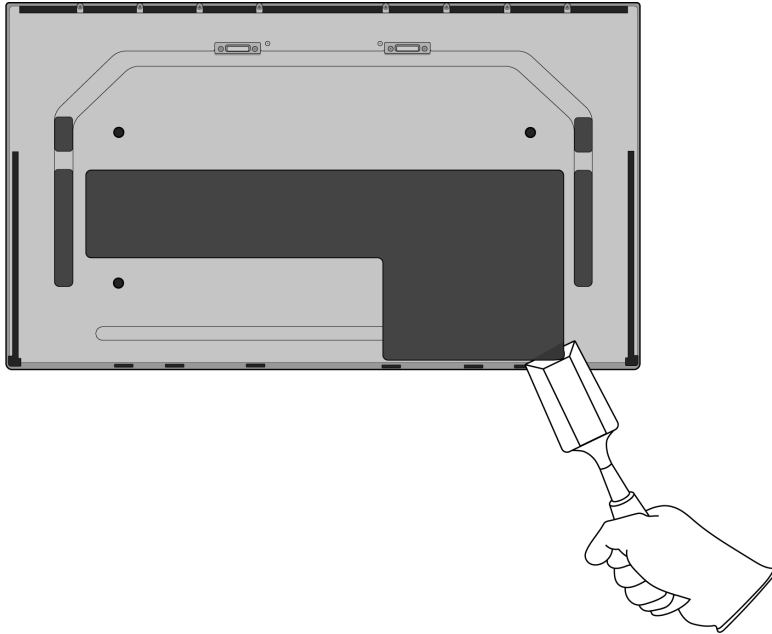

Tools Used



Fraction



Plastic sheet



10. Peel off the two remaining ribbon cables by hand.

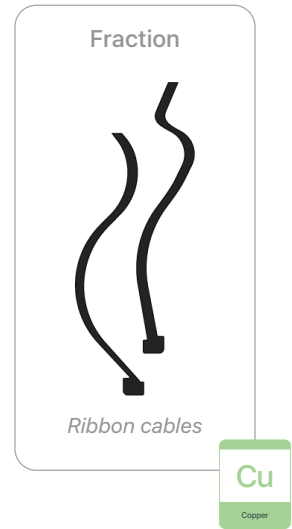
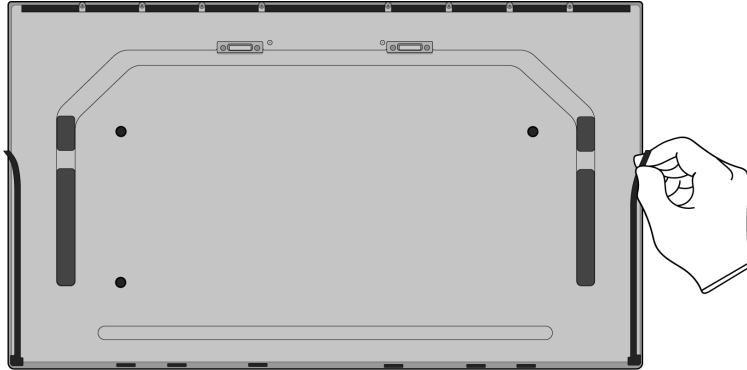

11. Remove the display cover.

» *Pry up the corner of the display cover.*

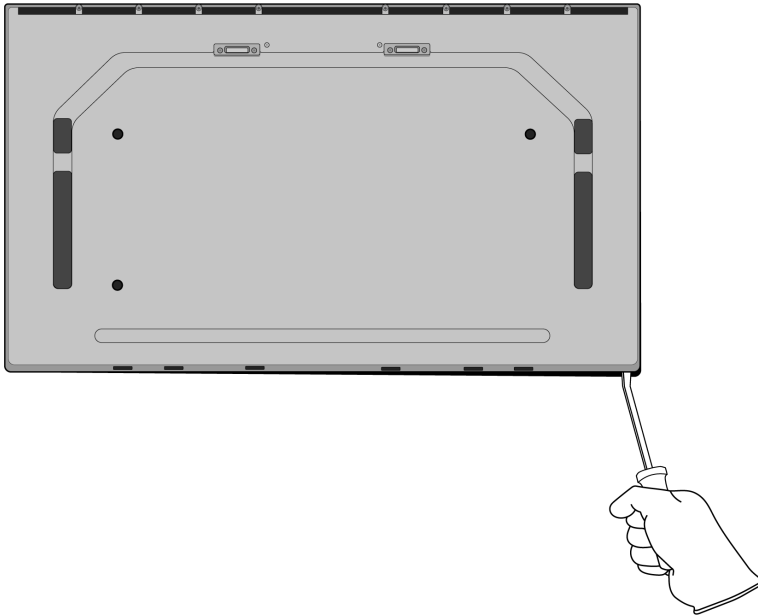

Tools Used

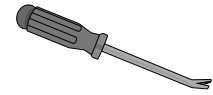

» *Lift off the display cover by hand. Set the LCD cell aside.*

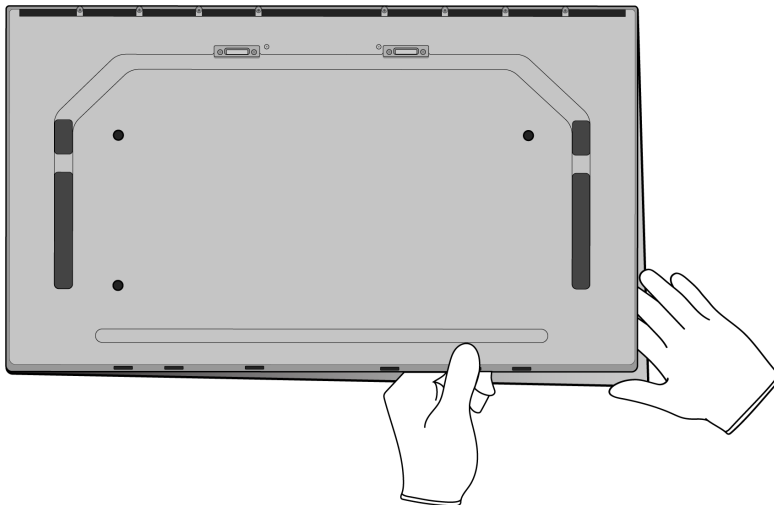

- 12.** Turn the display cover over and remove the LED logic board by hand.

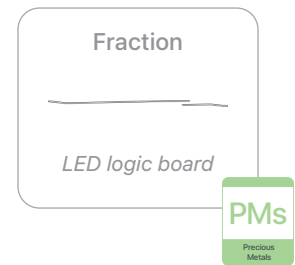
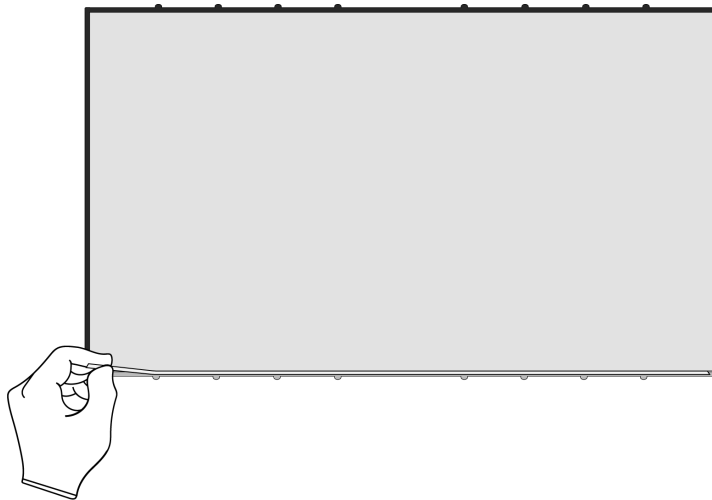
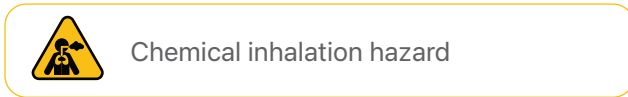

- 13.** Pull the plastic film off the display cover by hand.

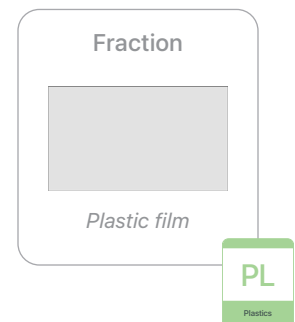
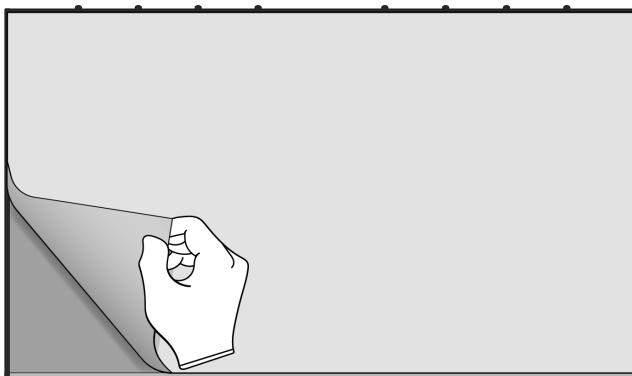

14. Pull the camera off the display cover.

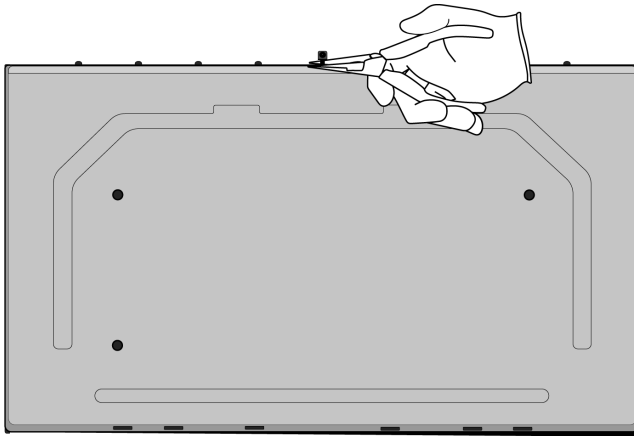

Tools Used

An illustration of a pair of tweezers.

Fraction

An illustration of a camera component with a lens and a black base.

Camera

PMs
Precious Metals

Fraction

An illustration of a grey display cover with a rectangular frame and four screws.

Display cover

Al
Aluminum

15. On the LCD cell, lift off the display films by hand.

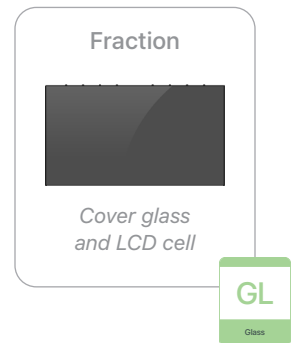
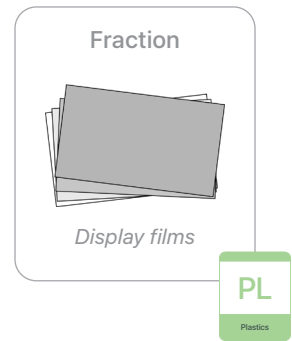
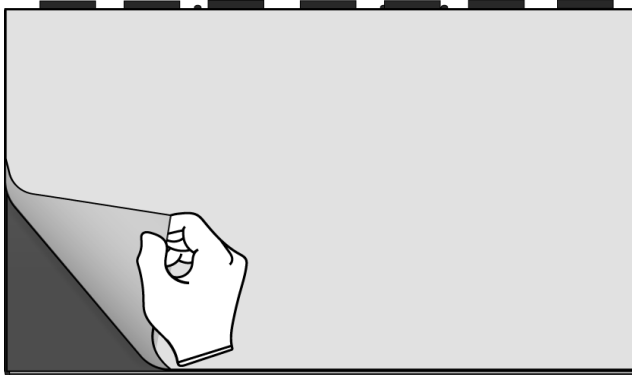

- 16.** On the enclosure, remove the seven Torx T20 fasteners from the stand bracket. Lift the enclosure from the stand.

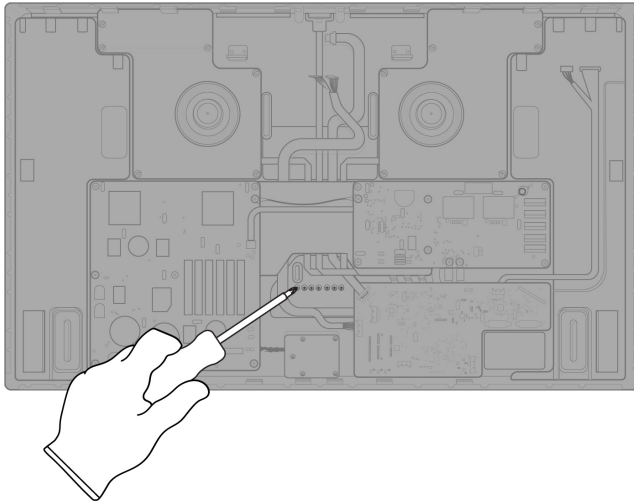

Tools Used

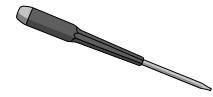

Fraction



Fasteners (x7)

Fe

Ferrous

Fraction

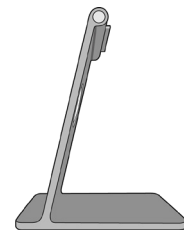

Stand

Al

Aluminum

- 17.** Cut off the three cables from the power supply logic board.

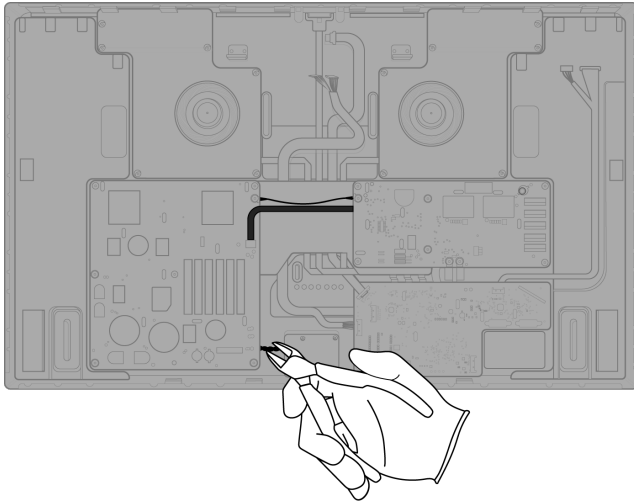

Tools Used

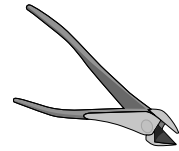

- 18.** Pry off the left power supply logic board.

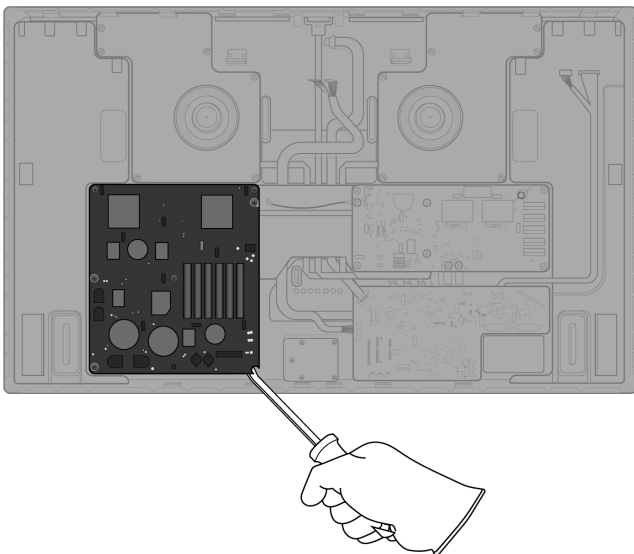

Tools Used

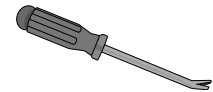

Fraction

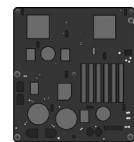

Left power supply logic board



- 19.** Pry off the left speaker. Unplug the cable going back to the main logic board by hand.

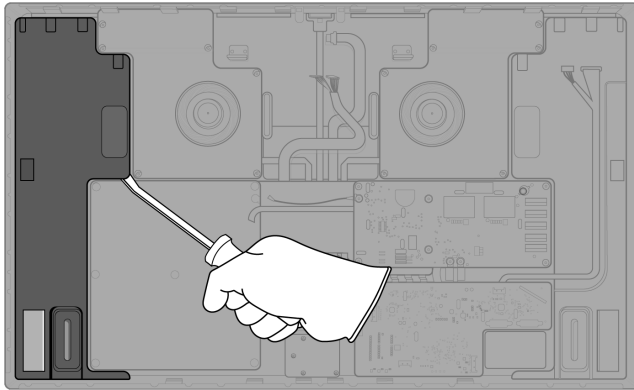

Tools Used

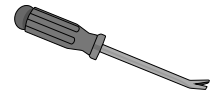

Fraction

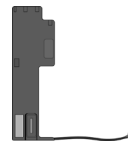

Left speaker

REE

Rare Earth
Elements

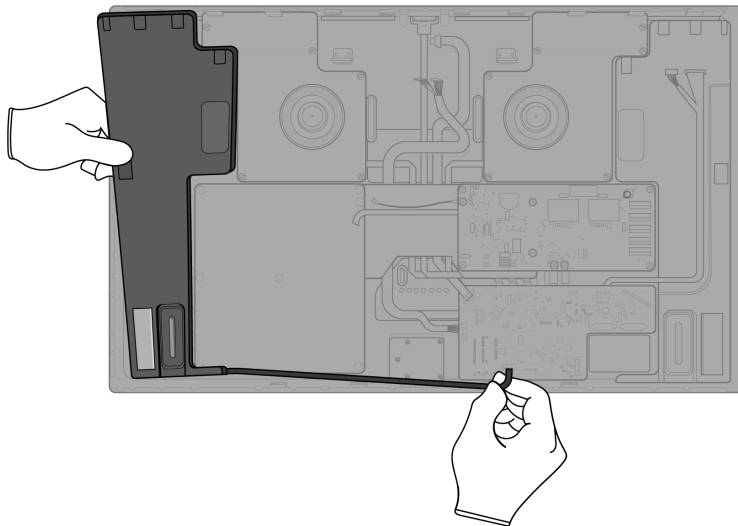

20. Pry off the left fan.

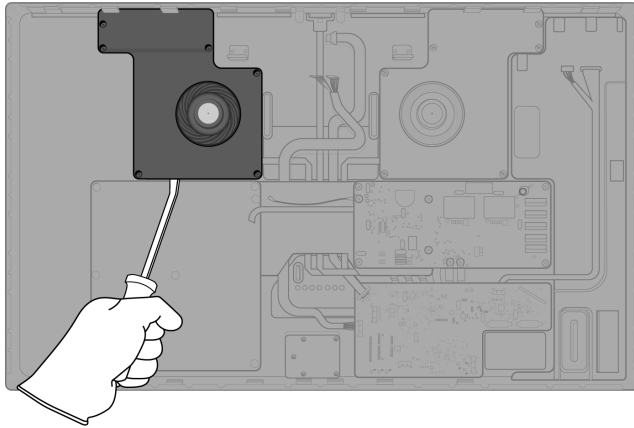

Tools Used

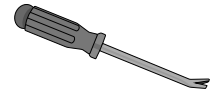

Fraction

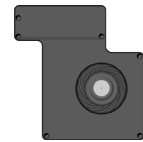

Left fan

Cu

Copper

21. Pry off the right fan.

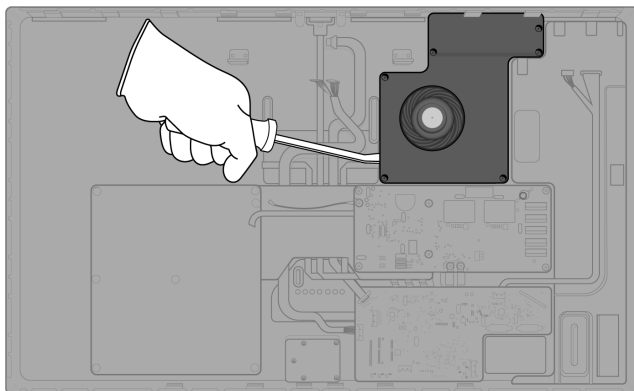

Tools Used

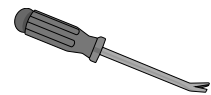

Fraction

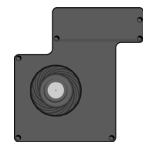

Right fan

Cu

Copper

22. Pry off the right speaker. Remove the attached ribbon cables by hand.

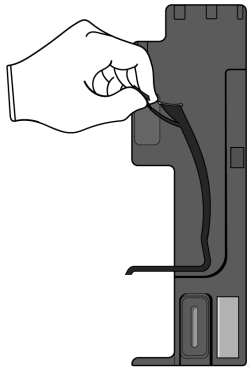
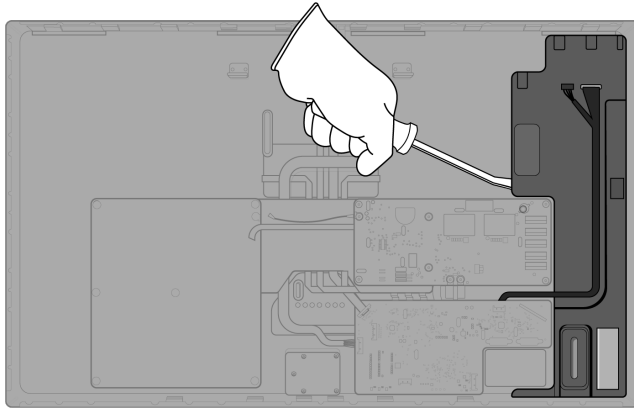

Tools Used

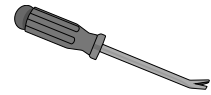

Fraction

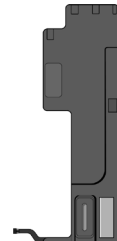

Right speaker

REE

Rare Earth
Elements

Fraction



Ribbon cables

Cu

Copper

- 23.** Pry off the right power supply logic board. Cut the two cables attached to the main logic board.

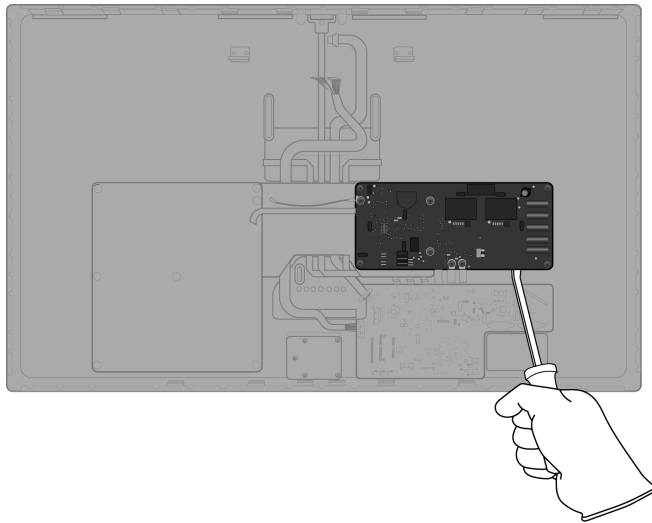

Tools Used

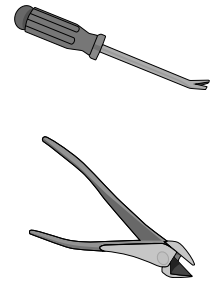

Fraction



*Right power supply
logic board*

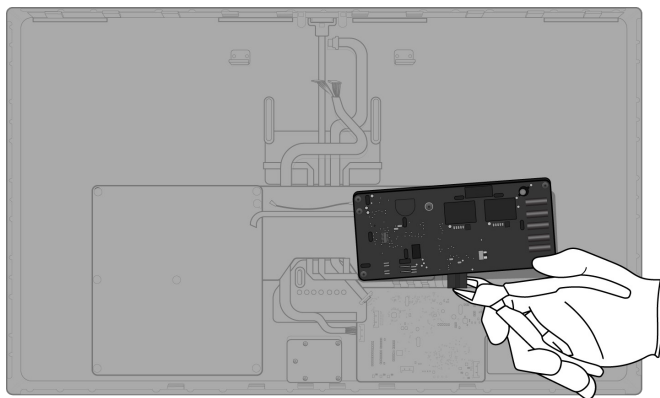

24. Pry off the main logic board with attached Thunderbolt port and USB-C ports.

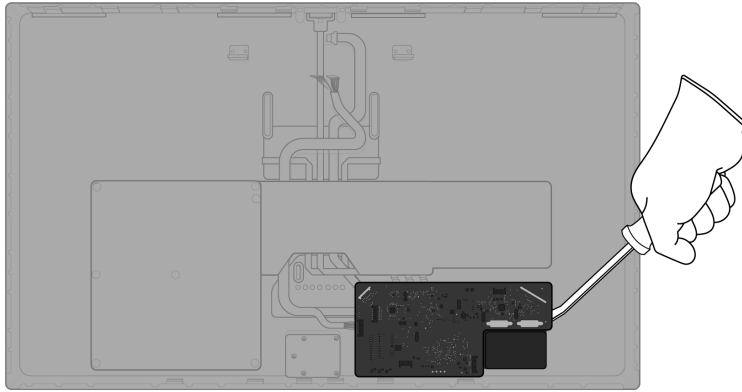

Tools Used

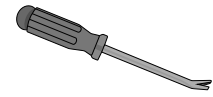

Fraction



Main logic board
and ports

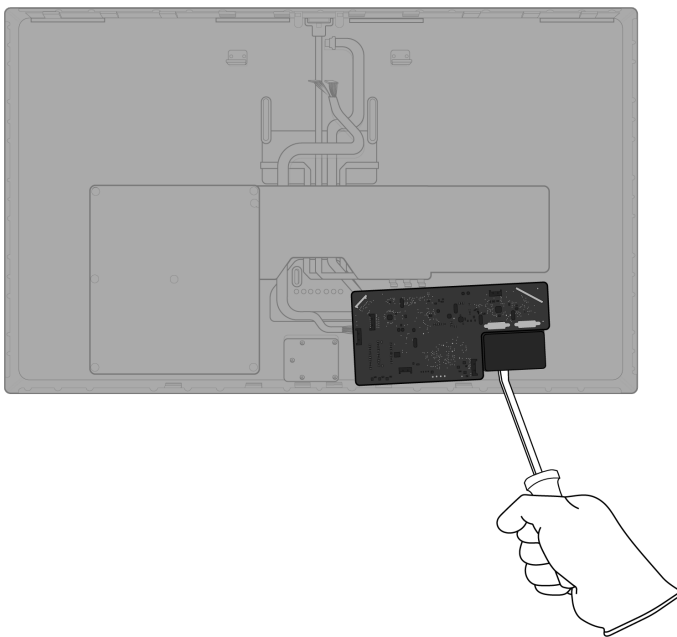

25. Remove the two display mounting tabs.

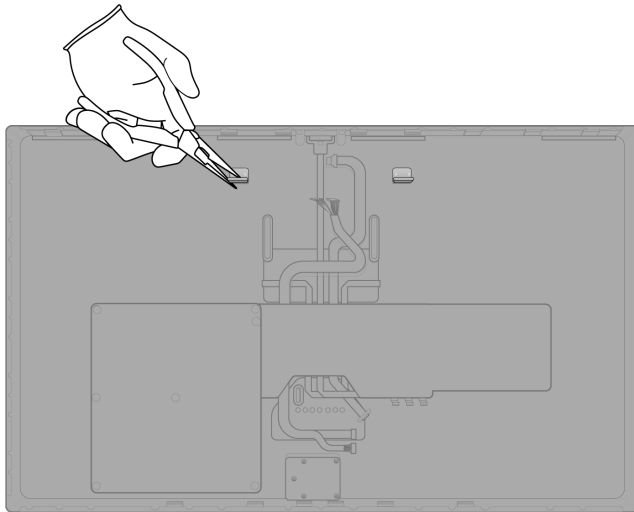

Tools Used

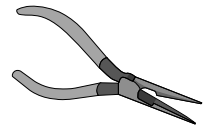

Fraction



Display mounting tabs

Fe

Ferrous

26. Remove the three plastic sheets by hand.

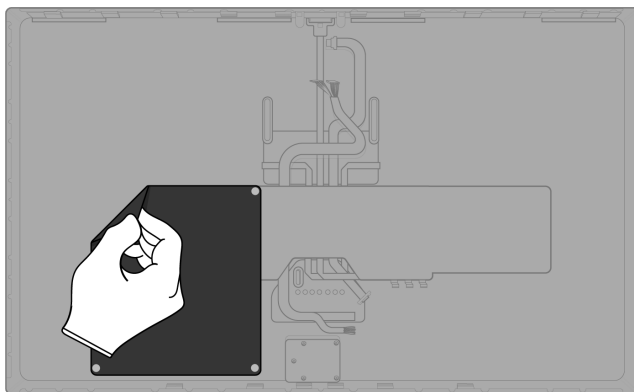

Fraction

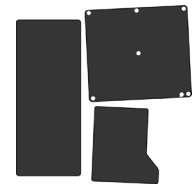

Plastic sheets

PL

Plastics

27. Pull off the remaining ribbon cables by hand.

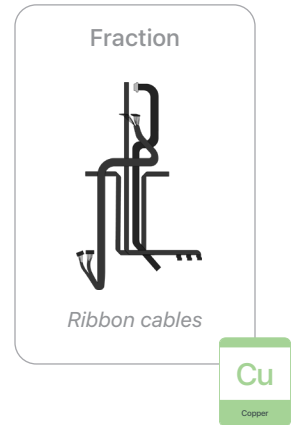
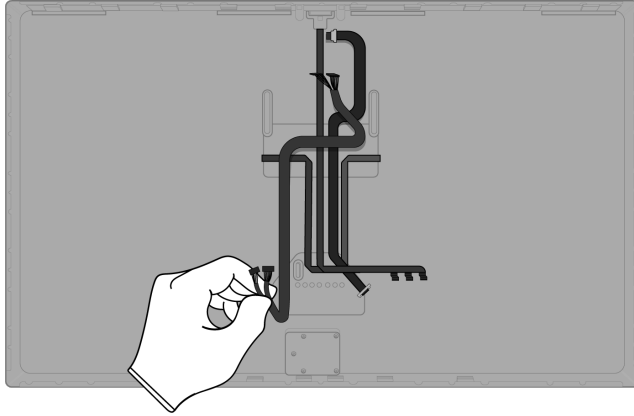

28. Pull off the two rubber bumpers and the copper sheet by hand.

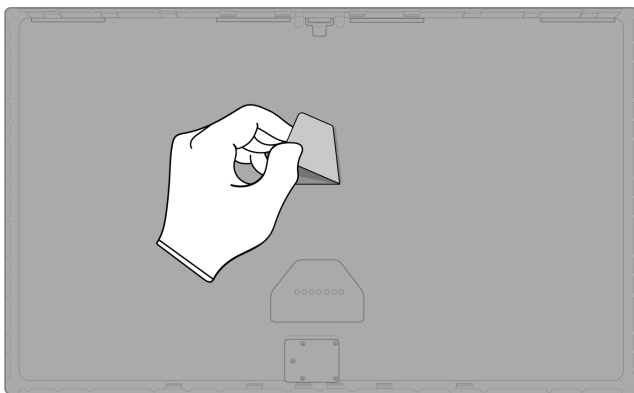
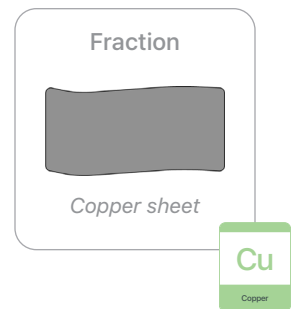
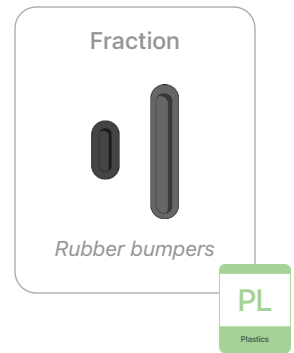
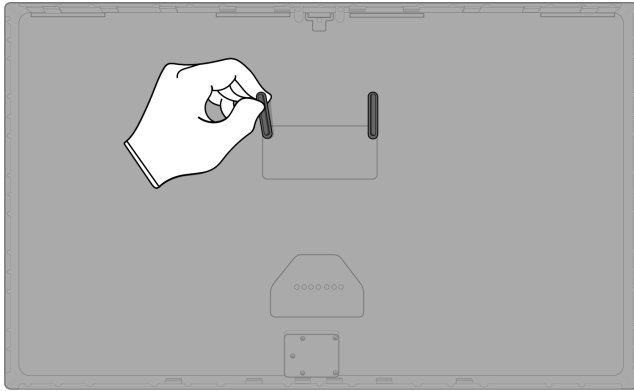

29. Pry off the power adapter.

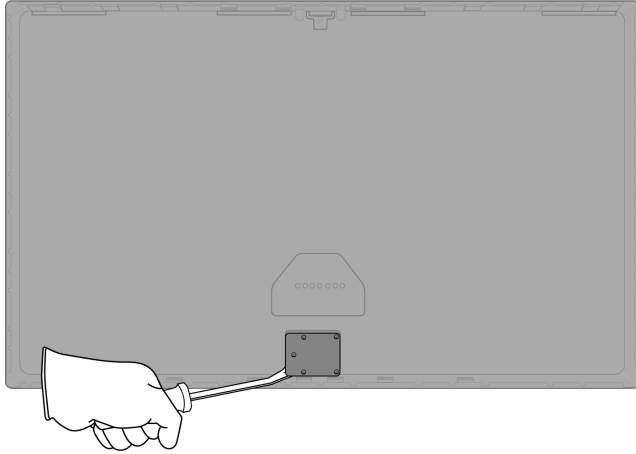

Tools Used

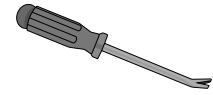

Fraction

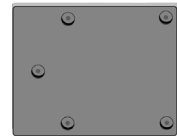

Power adapter

Cu
Copper

30. Pry off the stand bracket.

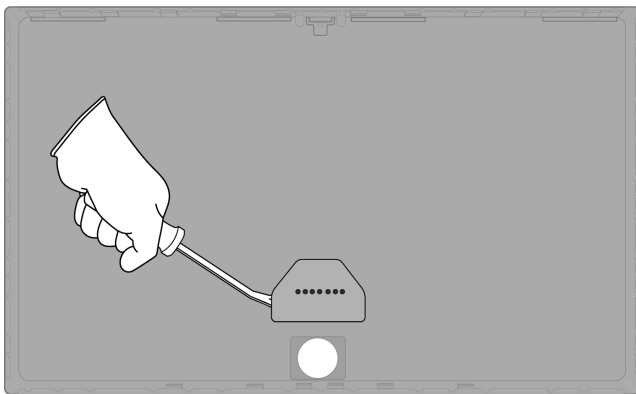

Tools Used

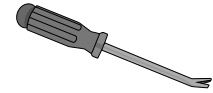

Fraction

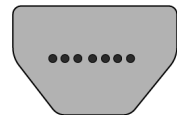

Stand bracket

Fe
Ferrous

31. Pry off the microphone array.

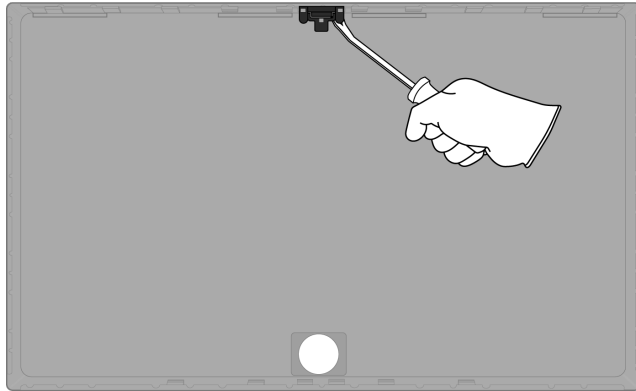

Tools Used

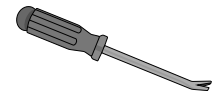

Fraction



Microphone array

Cu

Copper

Fraction

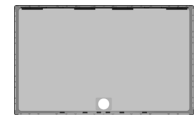





Enclosure

Al

Aluminum

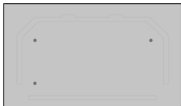
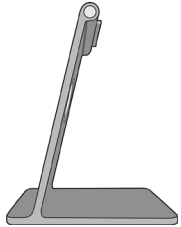
Material Categorization of Output Fractions

All outputs from this process must be managed, handled, and disposed of in accordance with applicable waste laws and regulations, including but not limited to the Waste Framework Directive and its national enactments in Europe.

Fraction	Downstream Processing
<p data-bbox="435 604 570 632">Aluminum</p>  <p data-bbox="435 800 570 827"><i>Display cover</i></p>  <p data-bbox="435 1108 532 1136"><i>Stand</i></p>  <p data-bbox="435 1310 548 1337"><i>Enclosure</i></p>	<p data-bbox="964 604 1276 632">Primary Target Material</p>  <p data-bbox="922 835 1315 863">Potential Additional Materials</p>  

Fraction

Downstream Processing

Ferrous

Primary Target Material



Logic board cover



Fasteners



Display mounting tabs

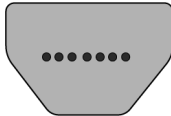

Stand bracket

Glass

Primary Target Material



Cover glass and LCD cell



Potential Additional Materials



Fraction

Downstream Processing

Logic Boards



Camera logic board with ribbon cable



Display logic board

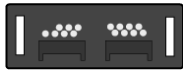

Connector logic board



LED logic board



Camera

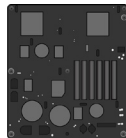

Left power supply logic board



Right power supply logic board



Main logic board and ports

Primary Target Material



Potential Additional Materials



Fraction

Downstream Processing

Mixed Electronics



USB-C cable



Power cable



Flex cable

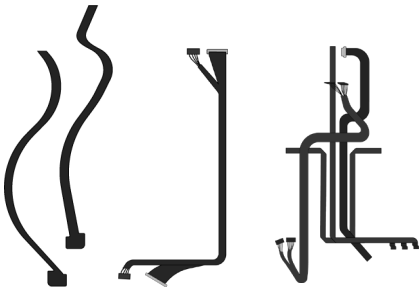

Ribbon cables

Primary Target Material



Potential Additional Materials



Mixed Electronics (cont.)

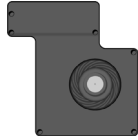

Left fan

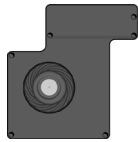

Right fan



Copper sheet

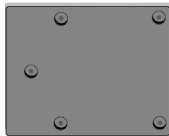

Power adapter



Microphone array

Fraction

Downstream Processing

Mixed Plastics

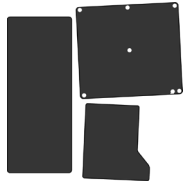

Plastic sheets



Plastic film

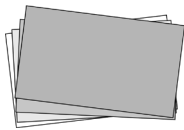

Display films

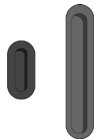

Rubber bumpers

Primary Target Material



Fraction

Downstream Processing

Rare Earth Magnets

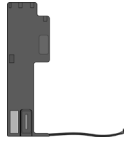

Left speaker

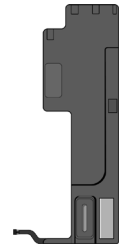

Right speaker

Primary Target Material



Potential Additional Materials

