



**iPad Pro 11-inch Wi-Fi**

**iPad Pro 11-inch Wi-Fi + Cellular**

**iPad Pro 11-inch (2nd generation) Wi-Fi**

**iPad Pro 11-inch (2nd generation) Wi-Fi + Cellular**

**iPad Pro 11-inch (3rd generation) Wi-Fi**

**iPad Pro 11-inch (3rd generation) Cellular mmW**

**iPad Pro 11-inch (3rd generation) Cellular 5G**

## **Apple Recycler Guide**

July 2023

# Contents

3	<a href="#">About This Guide</a>
4	<a href="#">Identification</a>
5	<a href="#">Directive 2012/19/EU Annex VII Components</a>
6	<a href="#">Safety Considerations</a>
9	<a href="#">Recommended Tools</a>
10	<a href="#">Disassembly Instructions</a>
32	<a href="#">Material Categorization of Output Fractions</a>

# About This Guide

Apple Recycler Guides provide guidance for electronics recyclers on how to disassemble products to maximize recovery of resources. The guides provide step-by-step disassembly instructions and information on the material composition to help recyclers direct fractions to the appropriate material recycler.

To conserve important resources, we work to reduce the materials we use and aim to one day source only recycled or renewable materials in our products. A key path to reaching that goal is resource recovery from end-of-life electronics.

Disassembly procedures are intended to be performed only by trained electronics recycling professionals. The recycler is responsible for independently evaluating and ensuring compliance with all applicable environmental, health, and safety laws related to the work. These include but are not limited to laws relating to the management, handling, shipping, and disposal of the outputs of this work as waste and laws in place to ensure the health and safety of all employees who support this work.

For questions or feedback about this guide, email [contactesci@apple.com](mailto:contactesci@apple.com).

**Note:** This guide may show images from other similar models, but the procedures are the same.

# Identification

You can find the model number on the back of the iPad Pro.

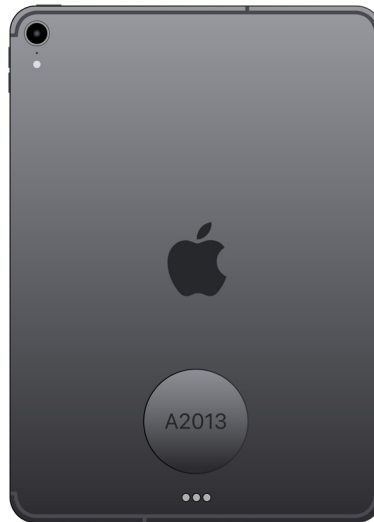

*Model numbers:*

*(Wi-Fi) A1980, A2228, A2377*

*(Wi-Fi + Cellular) A1934, A1979, A2013, A2068, A2230, A2301, A2331, A2459, A2469*

# Directive 2012/19/EU Annex VII Components

Directive 2012/19/EU Annex VII requirements apply to the following substances and components.

<b>Substance/Component</b>	<b>Apple Part Name</b>	<b>Removal Instructions</b>
Printed circuit board if the surface is greater than 10 square centimeters	Display logic board, main logic board	Follow steps 1–8
External electric cables	Power adapter, charge cable	Follow step 1
Battery	Lithium-ion polymer battery	Follow steps 1–6
Cover glass and liquid crystal display (LCD) cell if the surface is greater than 100 square centimeters	LCD cell	Follow steps 1–5
No further substances or components as listed in Annex VII		

# Safety Considerations

The recycler is responsible for independently evaluating all activities undertaken by its employees to perform or support the work and ensuring compliance with all applicable health and safety laws related to the work. These include but are not limited to laws relating to the health and safety of all employees who perform or support this work. The recycler is also responsible for evaluating the workspace and ensuring that the area in which the work is to be undertaken is designed using ergonomic best practices and meets all ergonomic requirements to ensure the protection of its employees.

## Personal Protective Equipment

Personal protective equipment should be worn during the entire recycling process.



Wear hand protection



Wear protective clothing



Wear eye protection



Wear foot protection

## Battery Safety

This product uses a lithium-ion polymer battery. Before beginning any disassembly work, ensure that a safe working procedure for handling lithium-ion batteries has been established, which could include discharging the batteries so that they can be more safely managed. The following considerations may also be included:

- Remove anything from your person that could conduct energy, such as jewelry and watches, to avoid electric shock to yourself or the logic board.
- To avoid the potential for thermal runaway and the release of potentially noxious fumes, don't puncture, strike, or crush lithium-ion polymer batteries or devices powered by them.
- Don't throw, drop, or bend the battery.
- Don't expose the battery to excessive heat or sunlight.
- Don't use tools that are sharp or conduct electricity.
- Keep your workspace clear of foreign objects and sharp materials.
- Dispose of batteries according to local environmental laws and guidelines.

## Workspace safety guidelines

- Use heat-resistant gloves and safety glasses.
- Keep a sand dispenser within arm's reach (2 feet or 0.6 m) on one side of the workstation, not above the workstation. The dispenser should be a wide-mouthed, quick-pour metal container with a flip-top lid or tray that contains 8–10 cups (1.9–2.4 L) of clean, dry, untreated sand.
- Keep the battery at least 2 feet (0.6 m) from paper and other combustible materials.
- Work in an area with adequate ventilation.

## Handling a thermal runaway

If you notice any of the following signs, a thermal runaway is likely underway, and you should act immediately:

- The lithium-ion polymer battery or a device containing one begins to smoke or emit sparks or soot.
- The battery pouch suddenly and quickly puffs out.
- You hear hissing or popping sounds.

**Don't** use water or an ABC/CO<sub>2</sub> fire extinguisher on a thermal runaway battery or a device containing one. Water and ABC/CO<sub>2</sub> fire extinguishers will not stop the reaction.

**Do** smother the battery or device immediately with plenty of clean, dry sand, dumped all at once. Timing is critical; the faster you pour all the sand, the faster the thermal runaway will stop.

**Do** leave the room for 30 minutes if the thermal runaway causes any irritation.

**Do** wait 30 minutes before touching the battery. Wear heat-resistant gloves and safety glasses to remove the battery from the sand, or use a touchless thermometer to measure the battery temperature. Only touch the battery when the event has finished.

**Do** dispose of the damaged battery or device (including any debris removed from the sand) according to local environmental laws and guidelines.

## LED Safety

Broken LEDs must be handled properly to ensure the safety of your employees and mitigate any hazards. Package broken LEDs in an appropriate container to properly manage the hazards associated with the materials and store only with compatible materials. All waste must be properly classified, packaged, and labeled in accordance with all relevant laws and regulations.

## Hazard Warnings



Broken glass hazard



Rechargeable battery hazard



Chemical exposure hazard



# Recommended Tools

Miniature pry bar

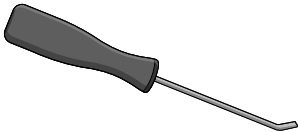

Nail-pulling screwdriver

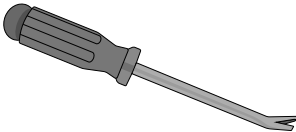

Plastic pry bar

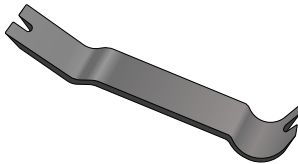

Screwdriver-handle pry bar

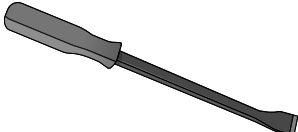

Tweezers



# Disassembly Instructions

## 1. Remove the power adapter and charge cable.

- » *Ensure that the iPad is turned off.*
- » *Unplug the power adapter. Disconnect both ends of the charge cable.*

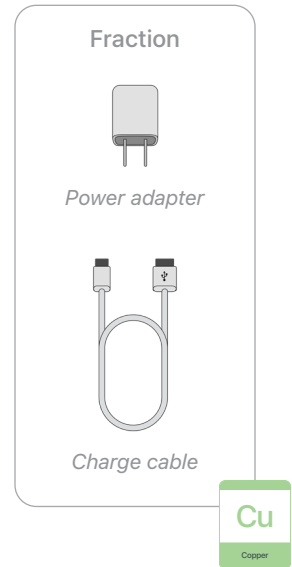

## 2. Remove the display.



Broken glass hazard



Chemical exposure hazard

- » *Hold the iPad at the edge of a counter with the display faceup.*
- » *Insert the tool tip into the bottom of the display. Push the handle down to pry the display from the enclosure.*

### Tools Used

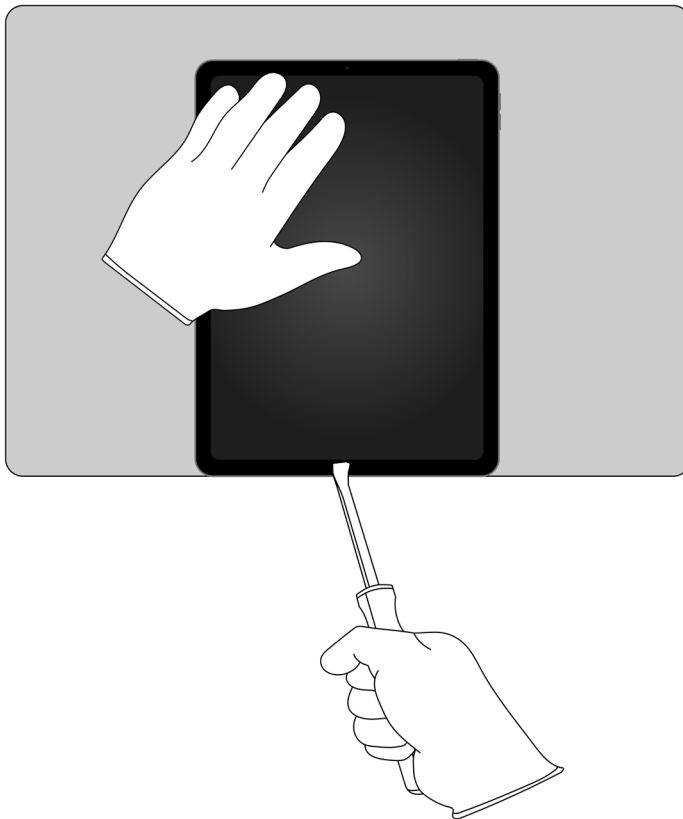
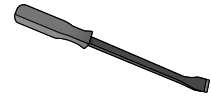

» Remove the display by hand. Set the enclosure aside.

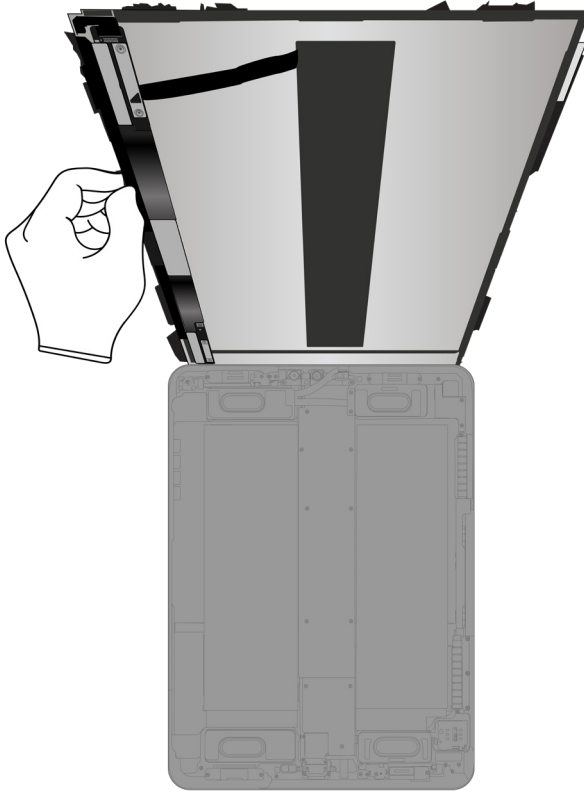

### 3. Remove the display logic board.

- » *Lay the display facedown.*
- » *Pry off the display logic board.*



#### Tools Used

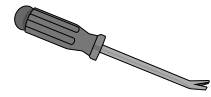

#### Fraction



*Display logic board*



4. Pry off the display cover.



Tools Used

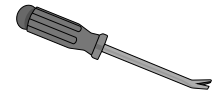

Fraction



Display cover

Fe

Ferrous

5. From the LCD cell, remove the display films.

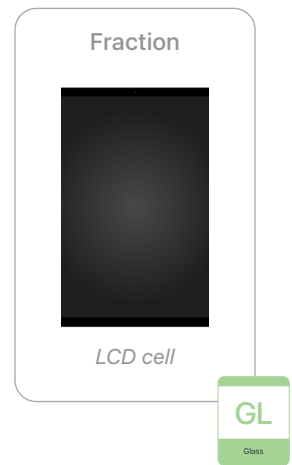
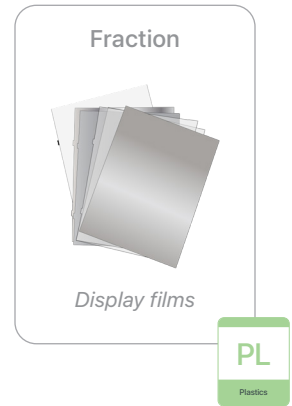
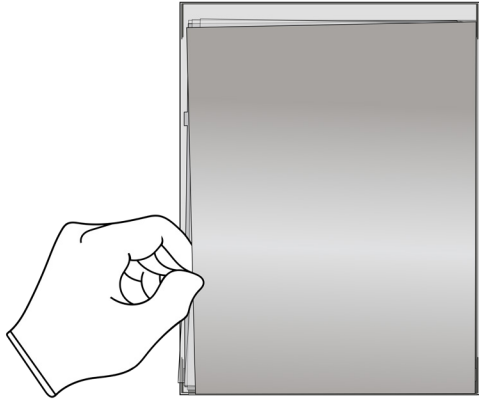

**6.** From the enclosure, pry off both lithium-ion polymer batteries.

 Rechargeable battery hazard

- » *Using tweezers, gently peel one of the battery adhesive tabs away from the battery.*
- » *Twist the tab around the tweezers until white adhesive appears. Continue twisting until the entire adhesive strip is removed.*
- » *Repeat this process for any remaining battery tabs. Continue with the plastic pry bar if needed.*

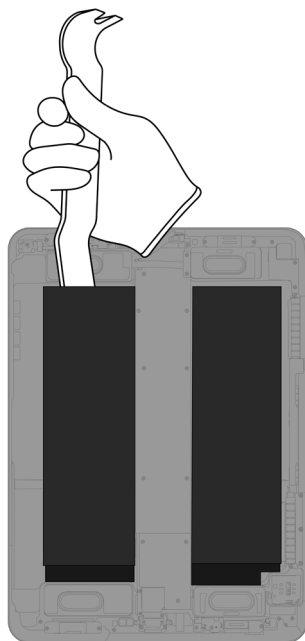

Tools Used

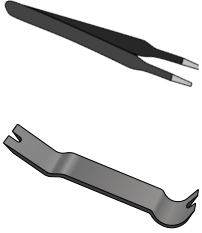
An illustration of a pair of tweezers and a plastic pry bar, both shown in a dark grey color.

Fraction

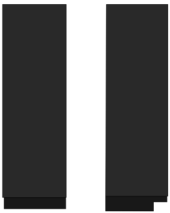
An illustration of two black, rectangular lithium-ion polymer batteries, one slightly behind the other.

Lithium-ion polymer batteries





7. Pry off the upper left woofer.

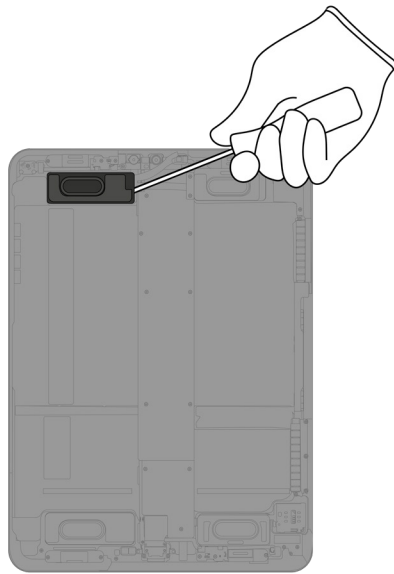

Tools Used



Fraction



Upper left woofer

REE

Rare Earth Elements

8. Pry off the main logic board.

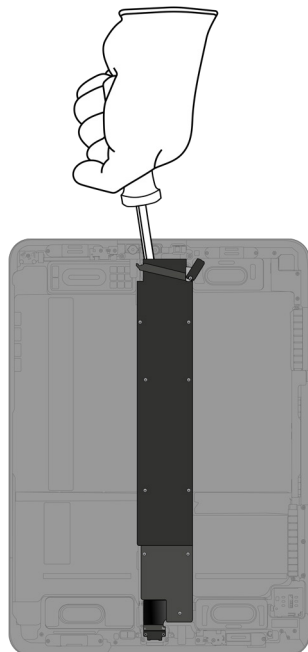

Tools Used

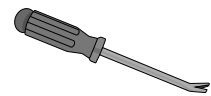

Fraction



Main logic board

PMs

Precious Metals

**9.** Pry off the upper right woofer.

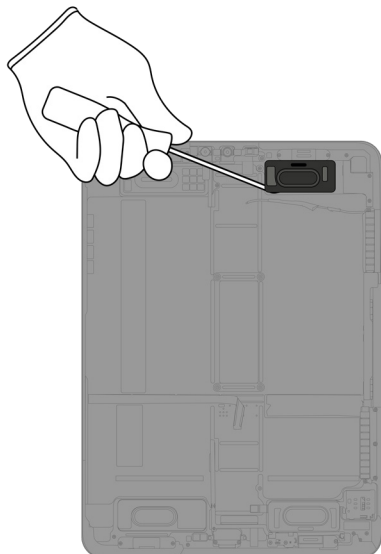

Tools Used



Fraction



Upper right woofer

REE

Rare Earth Elements

**10.** Pry off the rear camera.

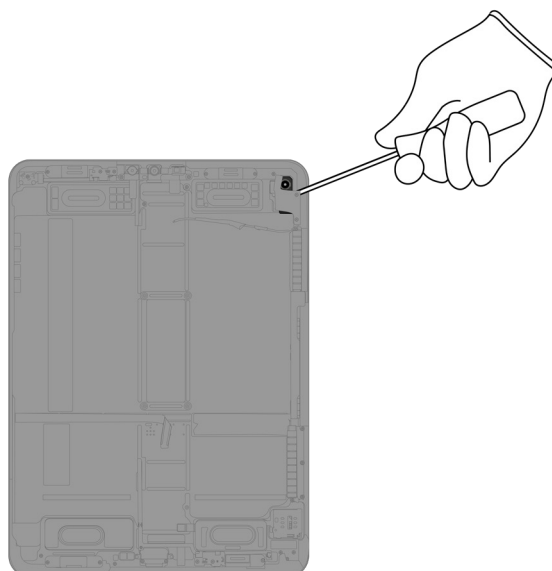

Tools Used



Fraction



Rear camera

PMs

Precious Metals

**11.** Pry off the microphone and strobe cover.

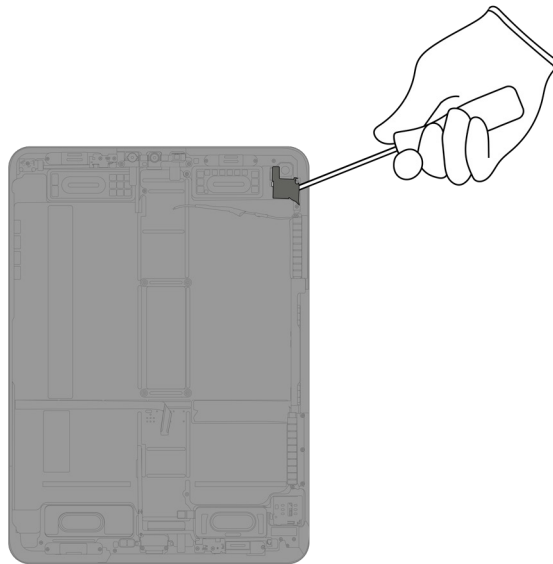

Tools Used



Fraction



Microphone and  
strobe cover

Fe

Ferrous

**12.** Pry off the microphone and strobe.

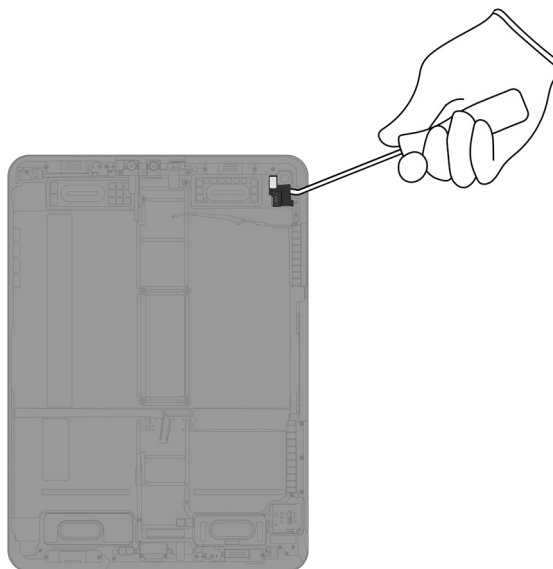

Tools Used



Fraction



Strobe



Microphone

Cu

Copper

**13.** Pry off the upper right tweeter.



Tools Used



Fraction



*Upper right tweeter*

**REE**  
Rare Earth  
Elements

**14.** Pry off the front camera.

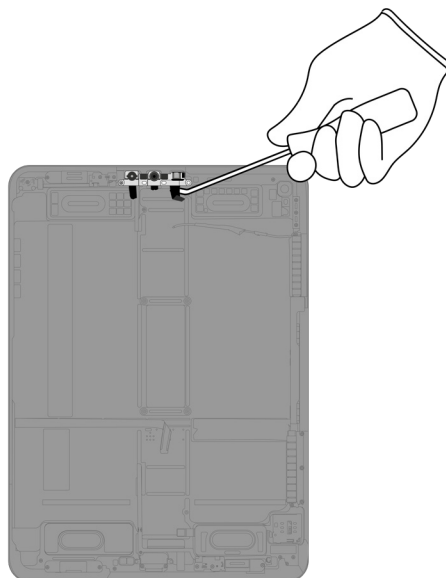

Tools Used



Fraction

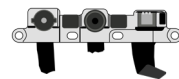

*Front camera*

**PMs**  
Precious  
Metals

**15.** Pry off the ribbon cable.

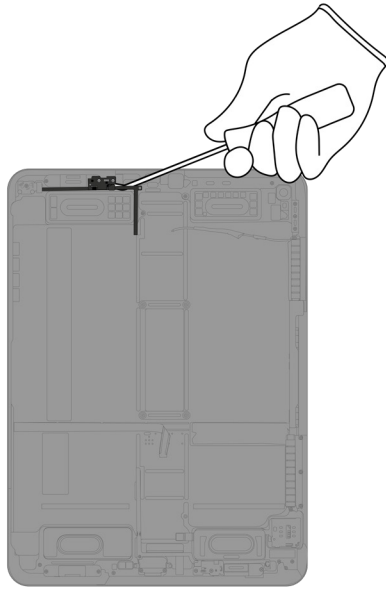

Tools Used



Fraction

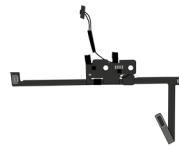

*Ribbon cable*

**Cu**  
Copper

**16.** Pry off the upper left tweeter.

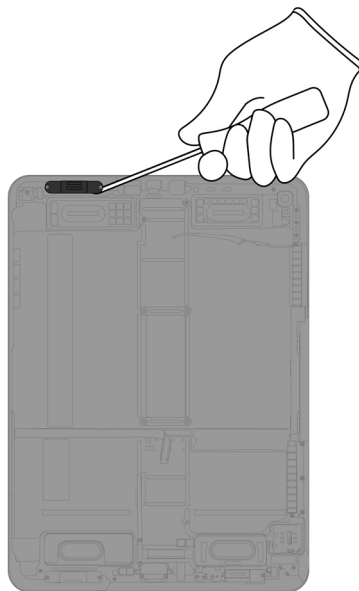

Tools Used



Fraction



*Upper left tweeter*

**REE**  
Rare Earth  
Elements

**17.** Pry off the ribbon cables.

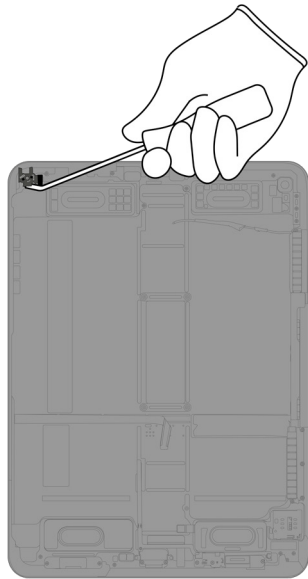

Tools Used



Fraction



Ribbon cables

Cu

Copper

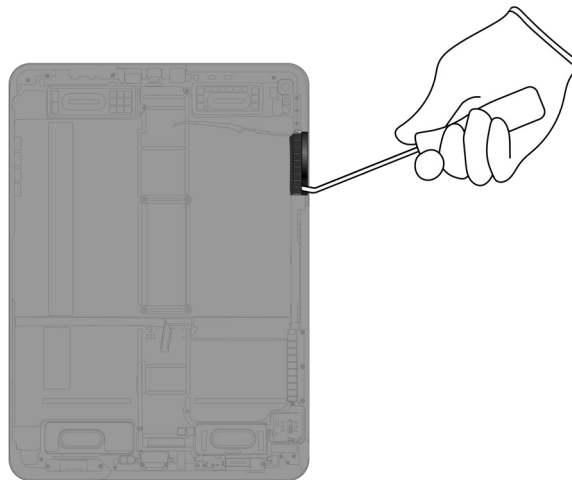

## 18. Pry off the Apple Pencil charging coil.

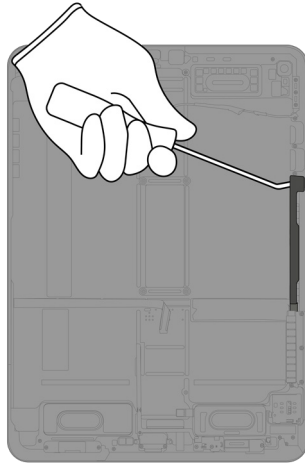

### Tools Used



### Fraction



*Apple Pencil charging coil*

**Cu**

Copper

## 19. Pry off the ribbon cable.

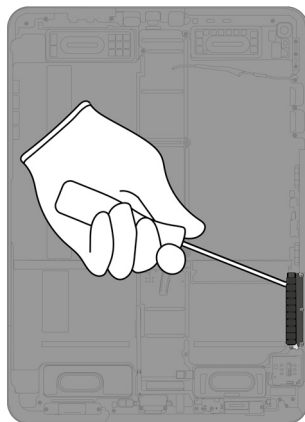

### Tools Used



### Fraction



*Ribbon cable*

**Cu**

Copper

**20.** (Wi-Fi + Cellular models only) Remove the SIM card and SIM tray. Separate the SIM card from the SIM tray.

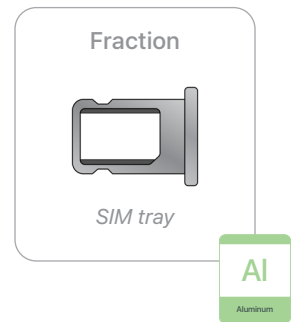
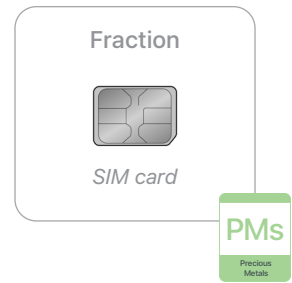
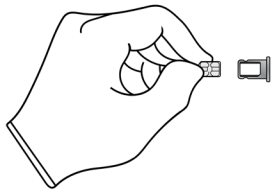
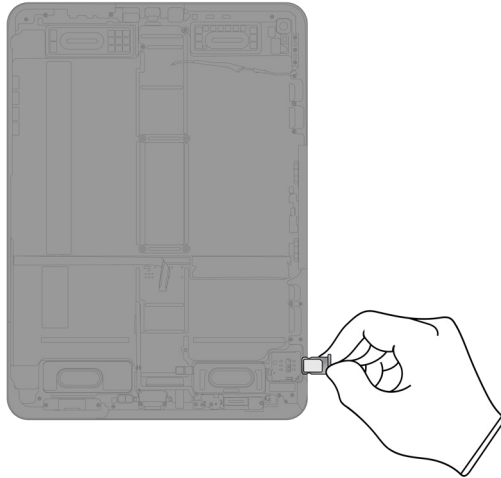



**21.** (Wi-Fi + Cellular models only) Pry off the SIM reader.

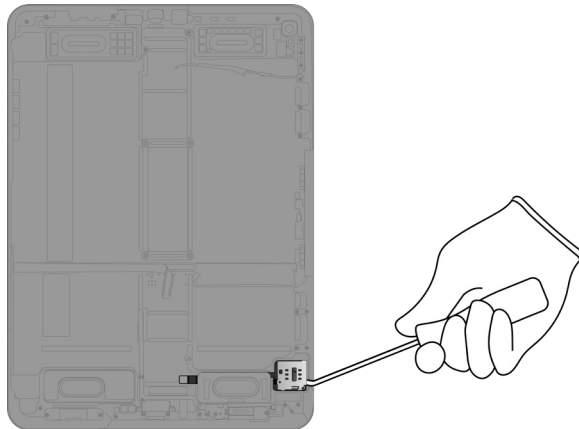

Tools Used



Fraction



*SIM reader*

**Cu**

Copper

**22.** Pry off the lower right woofer.

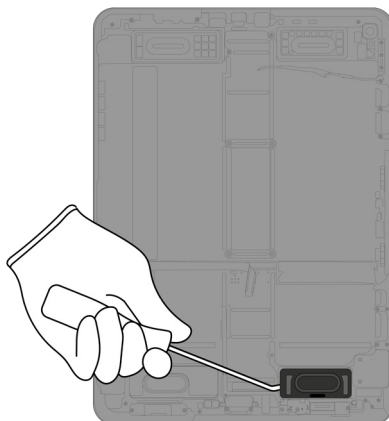

Tools Used



Fraction



*Lower right woofer*

**REE**

Rare Earth Elements

**23.** Pry off the ribbon cable.

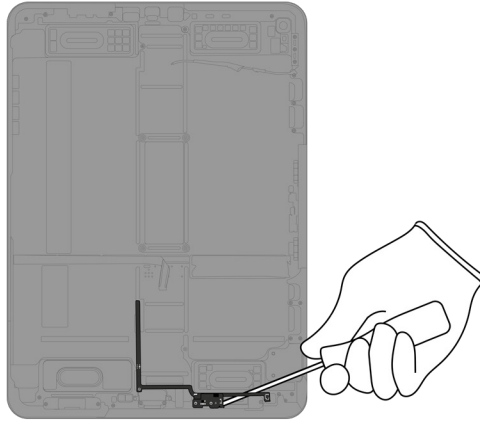

Tools Used



Fraction

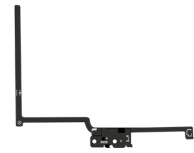

*Ribbon cable*

**Cu**  
Copper

**24.** Pry off the lower right tweeter.

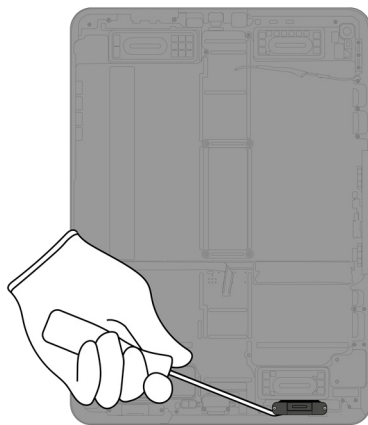

Tools Used



Fraction



*Lower right tweeter*

**REE**  
Rare Earth Elements

**25.** Pry off the USB-C port.

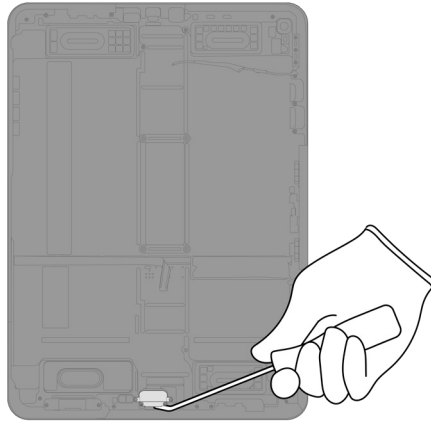

Tools Used



Fraction



USB-C port

Cu

Copper

**26.** Pry off the lower left woofer.

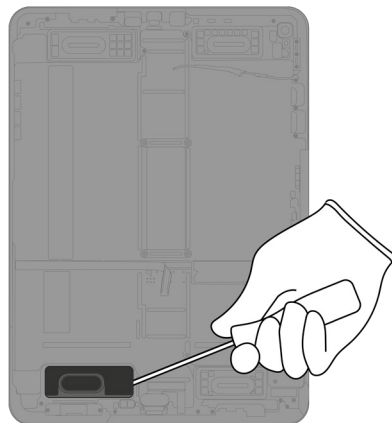

Tools Used



Fraction



Lower left woofer

REE

Rare Earth  
Elements

**27.** Pry off the lower left tweeter.

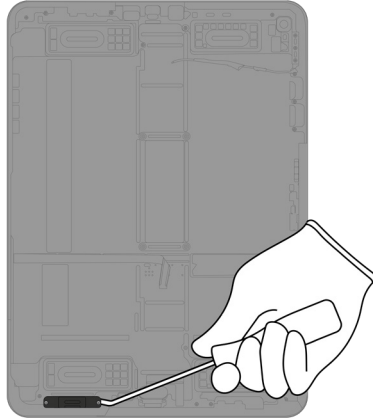

Tools Used



Fraction



Lower left tweeter

REE  
Rare Earth  
Elements

**28.** Pry off the Smart Connector.

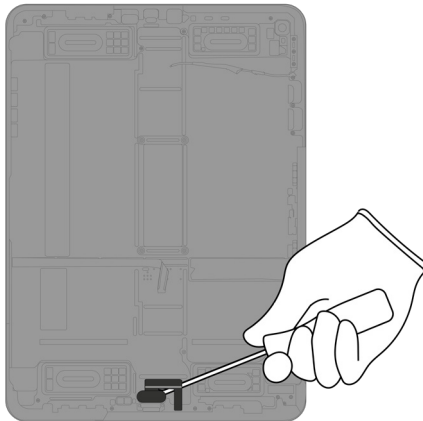

Tools Used



Fraction

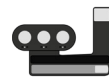

Smart Connector

Cu  
Copper

**29.** Pull off the remaining ribbon cables.

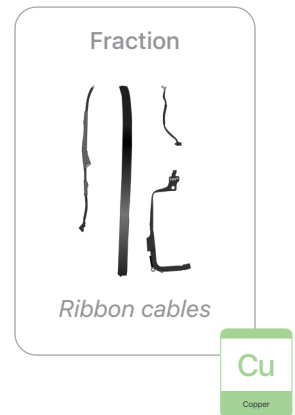
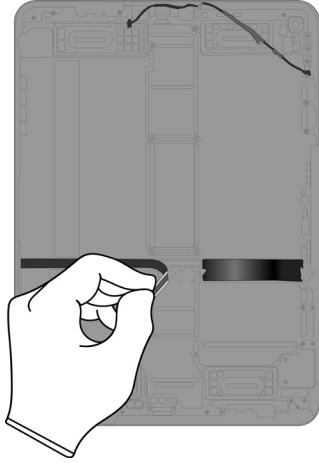

### 30. Pry off the microphone array.

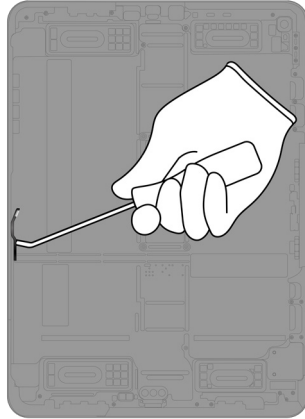

#### Tools Used



#### Fraction



*Microphone array*

**Cu**

Copper

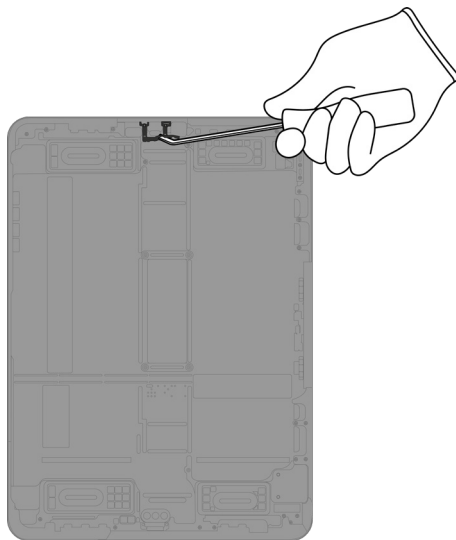

### 31. Pry the 68 magnets off the enclosure.

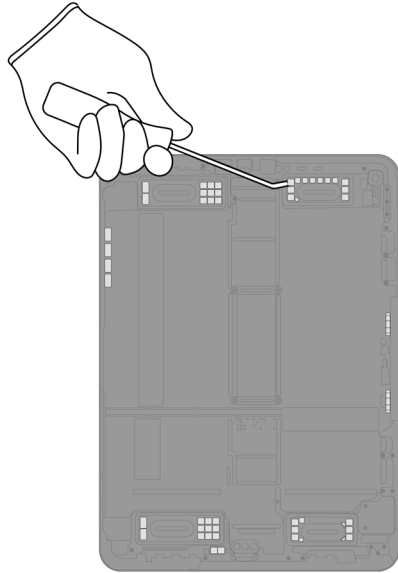

#### Tools Used



#### Fraction

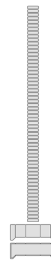

Magnets (x68)

REE

Rare Earth  
Elements

#### Fraction

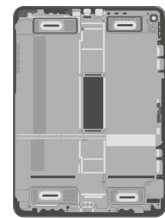



Enclosure



Al

Aluminum

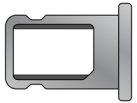
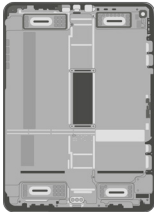
# Material Categorization of Output Fractions

All outputs from this process must be managed, handled, and disposed of in accordance with applicable waste laws and regulations, including but not limited to the Waste Framework Directive and its national enactments in Europe.

Fraction	Downstream Processing
<p data-bbox="435 604 570 632"><b>Aluminum</b></p>  <p data-bbox="459 793 545 821"><i>SIM tray</i></p>  <p data-bbox="451 1104 545 1131"><i>Enclosure</i></p>	<p data-bbox="964 604 1276 632"><b>Primary Target Material</b></p>  <p data-bbox="1101 699 1135 726">Al</p> <p data-bbox="1101 743 1138 758">Aluminum</p>

<p data-bbox="440 1224 565 1251"><b>Batteries</b></p>  <p data-bbox="358 1524 643 1551"><i>Lithium-ion polymer batteries</i></p>	<p data-bbox="964 1224 1276 1251"><b>Primary Target Material</b></p>  <p data-bbox="1101 1318 1135 1346">BT</p> <p data-bbox="1101 1362 1138 1377">Battery</p>
---	---



**Fraction**

**Downstream Processing**

**Ferrous**

**Primary Target Material**

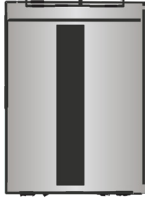

*Display cover*



*Microphone and strobe cover*



**Glass**

**Primary Target Material**

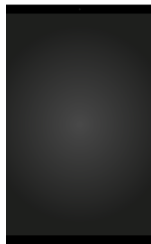

*LCD cell*



**Potential Additional Materials**



**Fraction**

**Downstream Processing**

**Logic Boards**



*Display logic board*



*Main logic board*



*Rear camera*

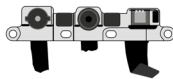

*Front camera*



*SIM card*

**Primary Target Material**



**Potential Additional Materials**



**Fraction**

**Downstream Processing**

**Mixed Electronics**



*Power adapter*

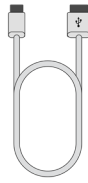

*Charge cable*



*Strobe*



*Microphone*



*Apple Pencil charging coil*



*SIM reader*

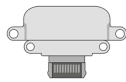

*USB-C port*

**Primary Target Material**



**Potential Additional Materials**



**Mixed Electronics (cont.)**

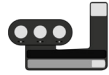

*Smart Connector*

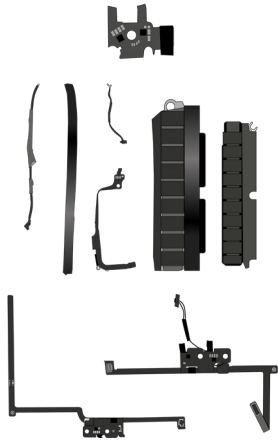

*Ribbon cables*



*Microphone array*

**Mixed Plastics**



*Display films*

**Primary Target Material**



**Fraction**

**Downstream Processing**

**Rare Earth Magnets**



*Upper left woofer*



*Upper right woofer*



*Upper right tweeter*



*Upper left tweeter*



*Lower right woofer*



*Lower right tweeter*



*Lower left woofer*



*Lower left tweeter*



*Magnets (x68)*

**Primary Target Material**



**Potential Additional Materials**

