



MacBook Pro (M2)

Apple Recycler Guide

July 2023

Contents

| | |
|----|---|
| 3 | About This Guide |
| 4 | Identification |
| 5 | Directive 2012/19/EU Annex VII Components |
| 6 | Safety Considerations |
| 9 | Recommended Tools |
| 10 | Disassembly Instructions |
| 22 | Material Categorization of Output Fractions |

About This Guide

Apple Recycler Guides provide guidance for electronics recyclers on how to disassemble products to maximize recovery of resources. The guides provide step-by-step disassembly instructions and information on the material composition to help recyclers direct fractions to the appropriate material recycler.

To conserve important resources, we work to reduce the materials we use and aim to one day source only recycled or renewable materials in our products. A key path to reaching that goal is resource recovery from end-of-life electronics.

Disassembly procedures are intended to be performed only by trained electronics recycling professionals. The recycler is responsible for independently evaluating and ensuring compliance with all applicable environmental, health, and safety laws related to the work. These include but are not limited to laws relating to the management, handling, shipping, and disposal of the outputs of this work as waste and laws in place to ensure the health and safety of all employees who support this work.

For questions or feedback about this guide, email contactesci@apple.com.

Identification

You can find the model number on the underside of the MacBook Pro.



Model number:
A2338

Directive 2012/19/EU Annex VII Components

Directive 2012/19/EU Annex VII requirements apply to the following substances and components.

| Substance/Component | Apple Part Name | Removal Instructions |
|---|---|----------------------|
| Printed circuit board if the surface is greater than 10 square centimeters | Main logic board, trackpad, data board assembly, light-emitting diode (LED) logic board | Follow steps 1–14 |
| External electric cables | Charge cable | Follow step 1 |
| Battery | Lithium-ion polymer batteries | Follow steps 1–3 |
| Cover glass and liquid crystal display (LCD) cell if the surface is greater than 100 square centimeters | LCD cell | Follow steps 1–12 |
| No further substances or components as listed in Annex VII | | |

Safety Considerations

The recycler is responsible for independently evaluating all activities undertaken by its employees to perform or support the work and ensuring compliance with all applicable health and safety laws related to the work. These include but are not limited to laws relating to the health and safety of all employees who perform or support this work. The recycler is also responsible for evaluating the workspace and ensuring that the area in which the work is to be undertaken is designed using ergonomic best practices and meets all ergonomic requirements to ensure the protection of its employees.

Personal Protective Equipment

Personal protective equipment should be worn during the entire recycling process.



Wear hand protection



Wear a mask



Wear eye protection



Wear foot protection



Wear protective clothing

Battery Safety

This product uses a lithium-ion polymer battery. Before beginning any disassembly work, ensure that a safe working procedure for handling lithium-ion batteries has been established, which could include discharging the batteries so that they can be more safely managed. The following considerations may also be included:

- Remove anything from your person that could conduct energy, such as jewelry and watches, to avoid electric shock to yourself or the logic board.
- To avoid the potential for thermal runaway and the release of potentially noxious fumes, don't puncture, strike, or crush lithium-ion polymer batteries or devices powered by them.
- Don't throw, drop, or bend the battery.
- Don't expose the battery to excessive heat or sunlight.
- Don't use tools that are sharp or conduct electricity.
- Keep your workspace clear of foreign objects and sharp materials.
- Dispose of batteries according to local environmental laws and guidelines.

Workspace safety guidelines

- Use heat-resistant gloves and safety glasses.
- Keep a sand dispenser within arm's reach (2 feet or 0.6 m) on one side of the workstation, not above the workstation. The dispenser should be a wide-mouthed, quick-pour metal container with a flip-top lid or tray that contains 8–10 cups (1.9–2.4 L) of clean, dry, untreated sand.
- Keep the battery at least 2 feet (0.6 m) from paper and other combustible materials.
- Work in an area with adequate ventilation.

Handling a thermal runaway

If you notice any of the following signs, a thermal runaway is likely underway, and you should act immediately:

- The lithium-ion polymer battery or a device containing one begins to smoke or emit sparks or soot.
- The battery pouch suddenly and quickly puffs out.
- You hear hissing or popping sounds.

Don't use water or an ABC/CO₂ fire extinguisher on a thermal runaway battery or a device containing one. Water and ABC/CO₂ fire extinguishers will not stop the reaction.

Do smother the battery or device immediately with plenty of clean, dry sand, dumped all at once. Timing is critical; the faster you pour all the sand, the faster the thermal runaway will stop.

Do leave the room for 30 minutes if the thermal runaway causes any irritation.

Do wait 30 minutes before touching the battery. Wear heat-resistant gloves and safety glasses to remove the battery from the sand, or use a touchless thermometer to measure the battery temperature. Only touch the battery when the event has finished.

Do dispose of the damaged battery or device (including any debris removed from the sand) according to local environmental laws and guidelines.

LED Safety

Broken LEDs must be handled properly to ensure the safety of your employees and mitigate any hazards. Package broken LEDs in an appropriate container to properly manage the hazards associated with the materials and store only with compatible materials. All waste must be properly classified, packaged, and labeled in accordance with all relevant laws and regulations.

Hazard Warnings



Rechargeable battery hazard



Sharp edges—cut hazard



Broken glass hazard



Chemical exposure hazard



Chemical inhalation hazard

Recommended Tools

Miniature pry bar

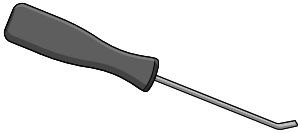

Plastic pry bar

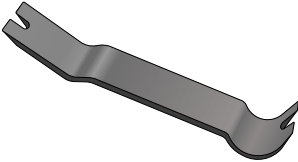

Screwdriver-handle pry bar

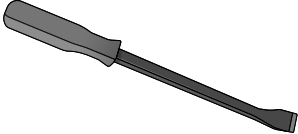

Torx T5 screwdriver

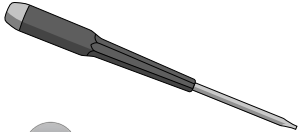

Disassembly Instructions

1. Remove the power adapter and charge cable.

- » *Ensure that the MacBook Pro is turned off.*
- » *Unplug the power adapter. Disconnect the charge cable.*

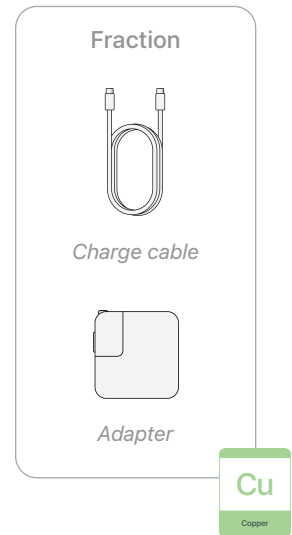

2. Carefully pry off the bottom case near the fasteners to avoid damaging the batteries.

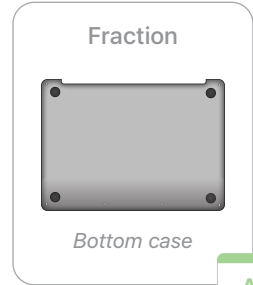
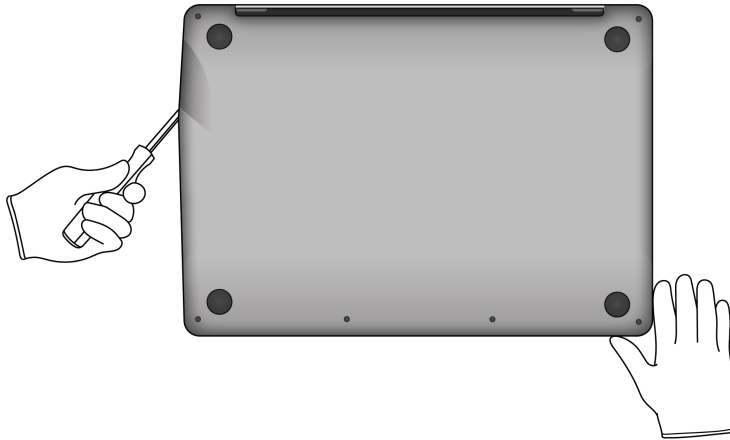

3. Carefully remove the three lithium-ion polymer batteries from the top case.

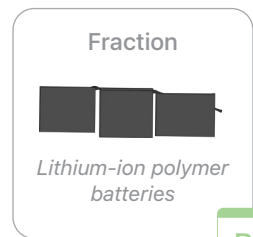
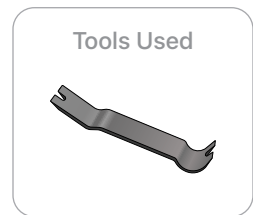
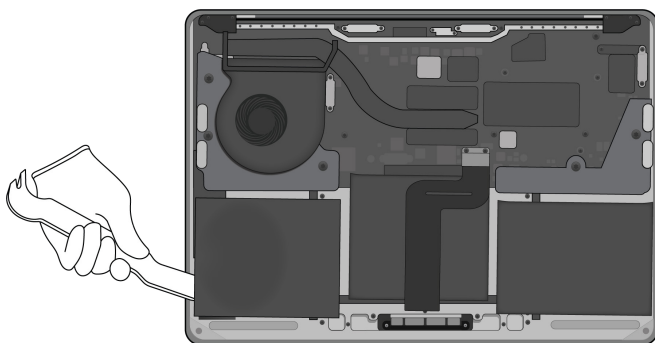
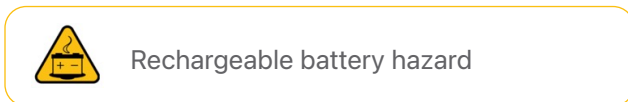

4. Pry off both speakers.

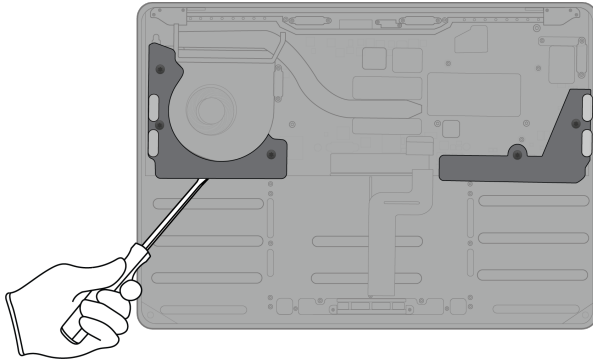

Tools Used

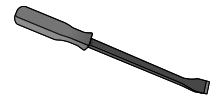

Fraction



Speakers

REE
Rare Earth
Elements

5. Pry off the main logic board.

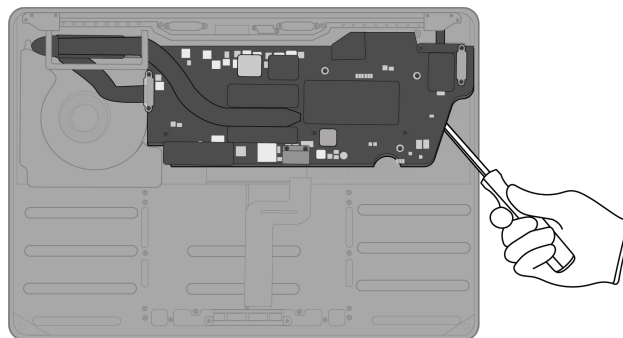

Tools Used

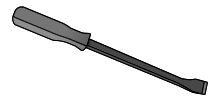

Fraction

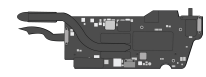

Main logic board

PMs
Precious
Metals

6. Pry off the fan.

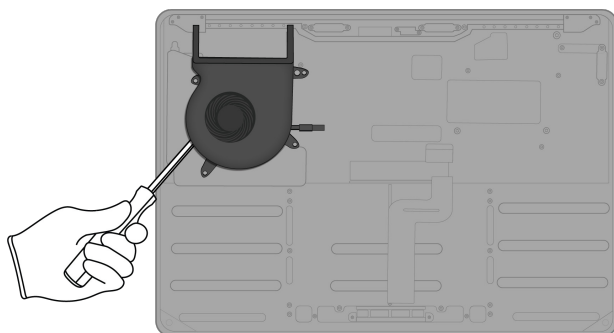

Tools Used

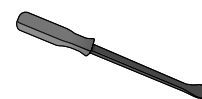

Fraction



Fan

Cu

Copper

7. Unscrew the 14 Torx T5 fasteners holding the trackpad to the top case.

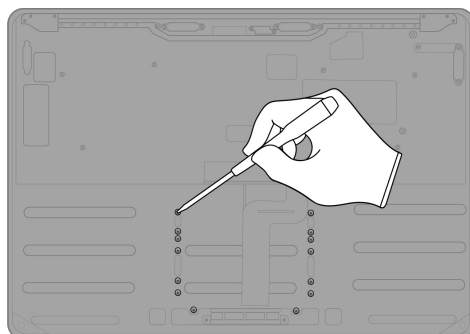

Tools Used

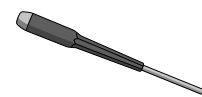

Fraction



Fasteners (x14)

Fe

Ferrous

8. Lift up the display. Remove the trackpad.

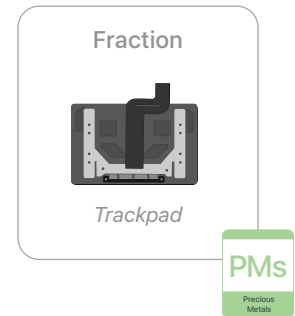
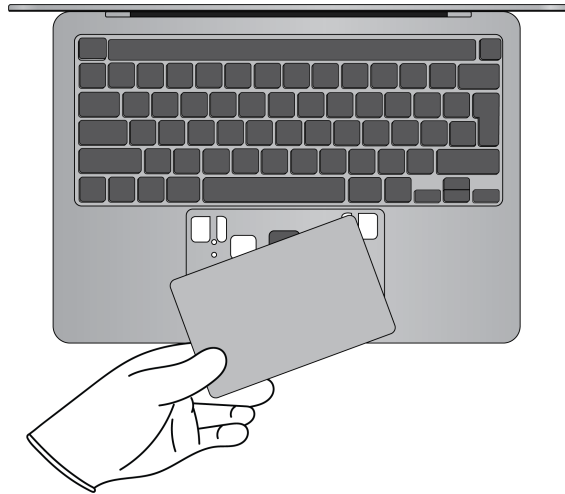

9. Separate the display and the top case by bending them back and forth until the hinges break. Set the display aside.



Sharp edges—cut hazard

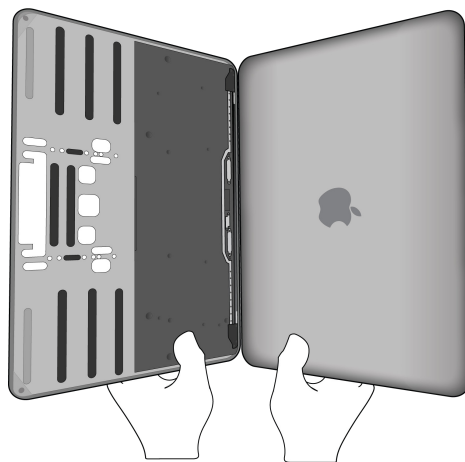

- 10.** Separate the keyboard and trackpad enclosure by breaking the top case in half.



Sharp edges—cut hazard

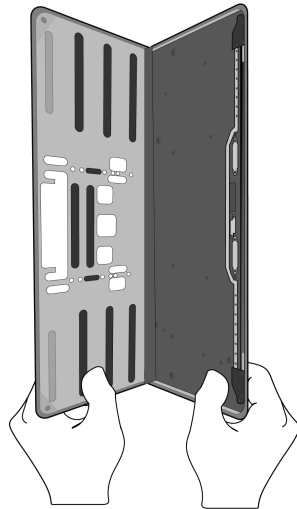

Fraction



Trackpad enclosure

Al

Aluminum

Fraction



Keyboard

Cu

Copper

- 11.** On the display, pull off the display gasket.

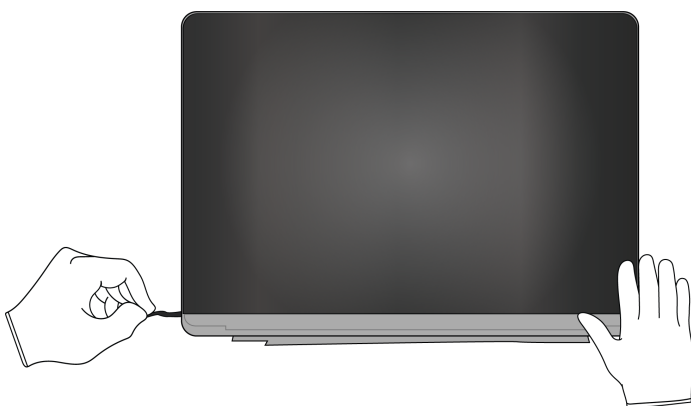

Fraction



Display gasket

PL

Plastics

12. Remove the LCD cell and the display films.

- » *Pry the LCD cell and the display films away from the display housing. Set the display housing aside.*



Broken glass hazard



Chemical exposure hazard

Tools Used

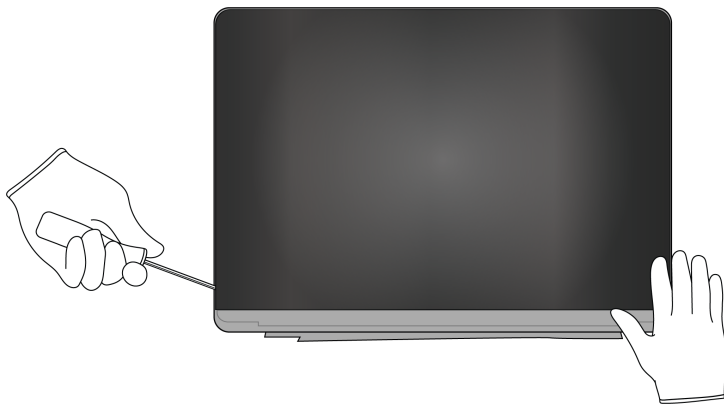

» Separate the LCD cell and the display films by hand.



Broken glass hazard



Chemical exposure hazard



Fraction



LCD cell

GL

Glass

Fraction



Display films

PL

Plastics

13. Pry the data board assembly off the display housing.

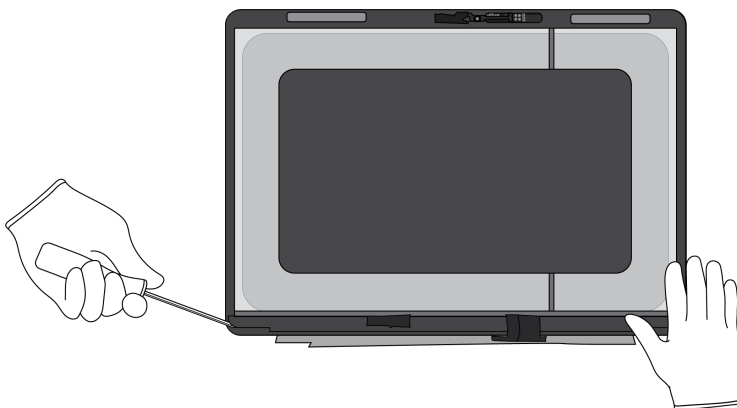

Tools Used



Fraction



Data board assembly

PMs

Precious Metals

14. Pry off the LED logic board.



Chemical inhalation hazard

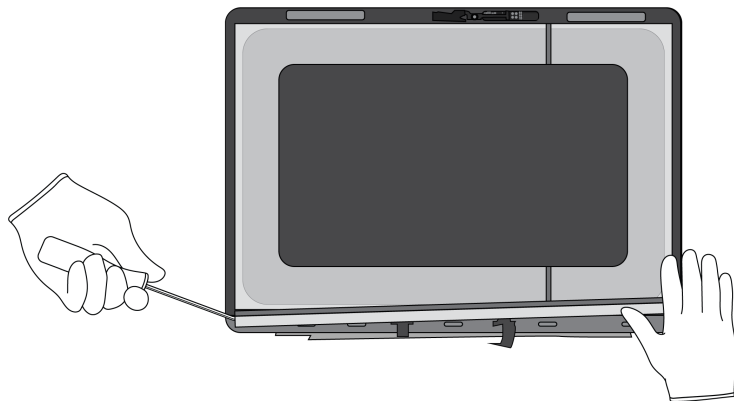

Tools Used



Fraction



LED logic board

PMs
Precious Metals

15. Pry off the display housing sheet.

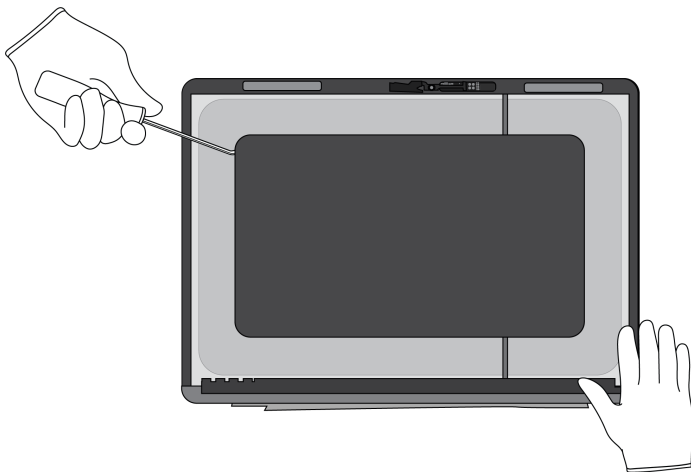

Tools Used



Fraction



Display housing sheet

PL
Plastics

16. Pull off the LED logic board ribbon cable.

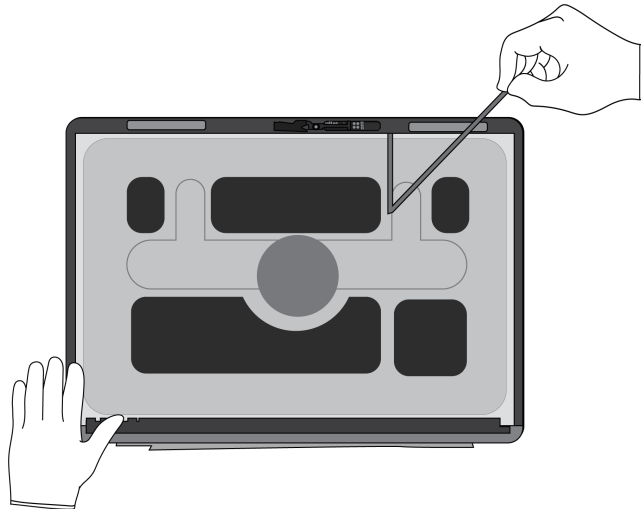

Fraction



LED logic board ribbon cable

Cu
Copper

A diagram showing a thin, dark ribbon cable. Below it is a green box with the chemical symbol 'Cu' and the word 'Copper' underneath.

17. Pry off the camera.

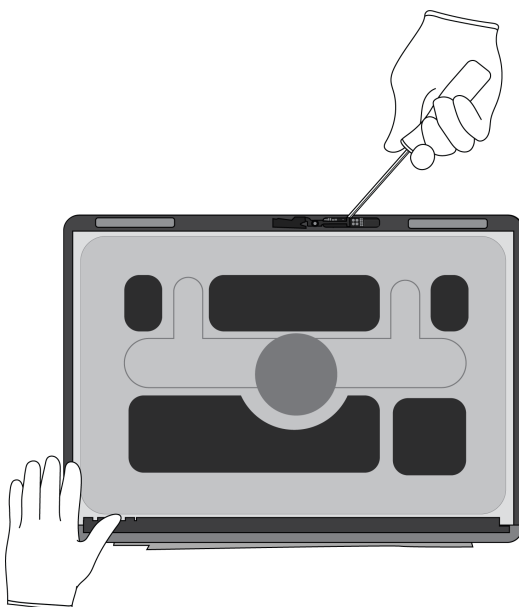

Tools Used

A simple line drawing of a screwdriver with a dark handle and a metal shaft.

Fraction



Camera

PMs
Precious Metals

A diagram showing a small, dark camera component. Below it is a green box with the letters 'PMs' and the words 'Precious Metals' underneath.

18. Remove the magnets.

» *Bend the display housing until the four magnets pop up.*

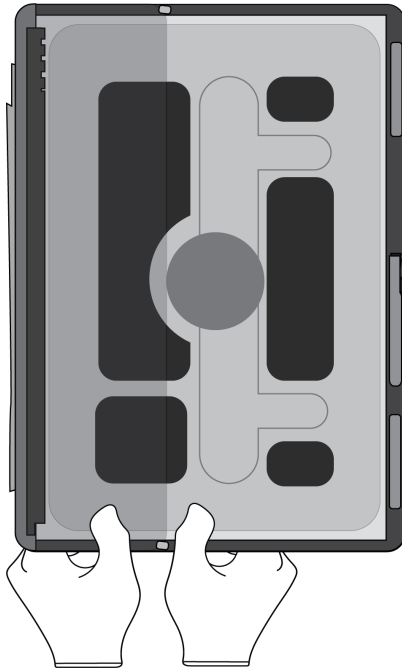

Tools Used



» Pry off the four magnets.

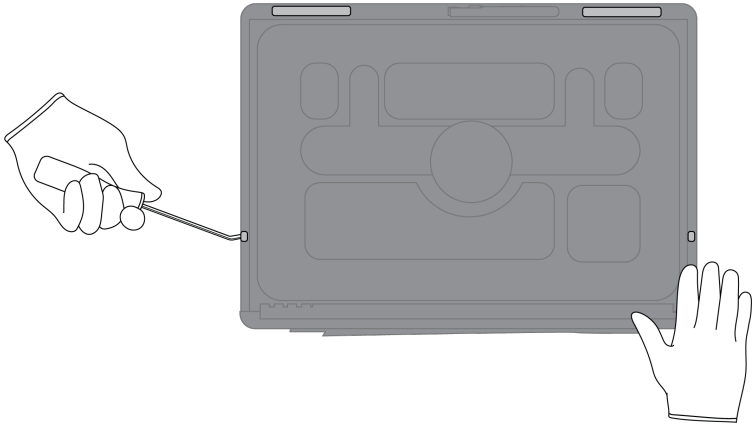

Fraction

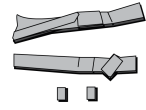

Magnets

REE

Rare Earth Elements

Fraction

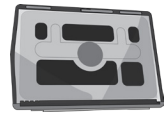









Display housing

Al

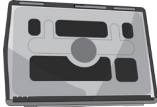
Aluminum

Material Categorization of Output Fractions

All outputs from this process must be managed, handled, and disposed of in accordance with applicable waste laws and regulations, including but not limited to the Waste Framework Directive and its national enactments in Europe.

| Fraction | Downstream Processing |
|---|---|
| <p data-bbox="435 594 565 621">Aluminum</p>  <p data-bbox="440 814 560 835"><i>Bottom case</i></p>  <p data-bbox="407 972 594 993"><i>Trackpad enclosure</i></p>  <p data-bbox="423 1188 578 1209"><i>Display housing</i></p> | <p data-bbox="963 594 1271 621">Primary Target Material</p>  <p data-bbox="930 821 1304 848">Potential Additional Material</p>   |
| <p data-bbox="440 1308 560 1335">Batteries</p>  <p data-bbox="358 1451 643 1472"><i>Lithium-ion polymer batteries</i></p> | <p data-bbox="963 1308 1271 1335">Primary Target Material</p>  |

Fraction **Downstream Processing**

Ferrous



Fasteners (x14)

Primary Target Material



Glass

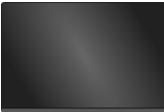

LCD cell

Primary Target Material



Potential Additional Materials



Fraction

Downstream Processing

Logic Boards

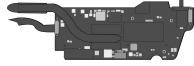

Main logic board

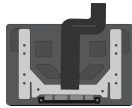

Trackpad



Data board assembly



LED logic board



Camera

Primary Target Material



Potential Additional Materials



Fraction

Downstream Processing

Mixed Electronics

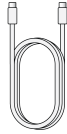

Charge cable



Adapter

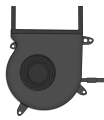

Fan



Keyboard



LED logic board ribbon cable

Primary Target Material



Potential Additional Materials



Fraction

Downstream Processing

Mixed Plastics



Display gasket

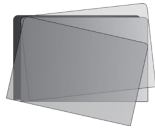

Display films



Display housing sheet

Primary Target Material



Rare Earth Magnets



Speakers

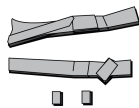

Magnets

Primary Target Material



Potential Additional Materials

